

CA Inter | CS Executive | CMA Inter

Chart Book

INCOME TAX

Relevant for May/June/Sep /Dec 25 & Jan 2026



- ✓ Applicable for New Syllabus
- ✓ Fully ammended as per Finance Act 2024
- ✓ Best Book for Revising GST
- ✓ Summarize full GST in 34 Pages
- ✓ Full Coloured Book

CA Inter/CS Executive/CMA Inter
New syllabus
Income tax

CRUX
BOOK

As per finance Act 2024

By CA Vivek Gaba(YouR VG SIR)

PREFACE

With great joy, I present **Income Tax Crux Book for CA Inter/CS Executive/CMA inter[may/june 2025 & Onwards]**, a guide to support your success.

I am deeply grateful Shri Nangli Niwasi Bhagwan Ji and **to my parents** for their unconditional love and guidance.

To my wife for her unwavering support.

To my sister and brother for their constant encouragement and joy.

A heartfelt thanks **to all the students** for their trust and appreciation—it fuels my dedication.

May we always cherish the bonds that strengthen us, and may this book be a guiding light on your journey.

ACKNOWLEDGEMENT

Special thanks

To Mr.Krishna vyas[Class student] for immense efforts in creating & designing this book.

Index		
ch.	chapter name	Page
1	Basic concepts	1-4
2	Residence & Scope of Total Income	5
3	Salaries	6-9
4	Income from house property	10
5	Profits & gains of business or profession	11-15
6	Capital gains	16-19
7	Income from Other sources	20
8	Income of other Persons included in assessee's TI	21
9	Aggregation of income, setoff and carry forward of losses	22
10	Deduction from Gross total income	23-25
11	Alternate Minimum tax	25
12	Advance tax, TDS & TCS	26-29
13	Return	30

Abbreviation			
PY	Previous year	IPPY	Immediately preceeding previous year
AY	Assessment year	ROR	Resident and ordinary Resident
RPY	Relevant Previous year	RNOR	Resident and not ordinary Resident
NR	Non resident	LTCG	Long term capital gain
R	Resident	STCG	Short term capital gain
GAV	Gross annual value	AOP	Associate of person
FR	Fair rent	BOI	Body of individual
MV	Municipal value	AJP	Artificial Juridical Persons
SR	Standard rent	H&E cess	Health and education cess
AR	Actual rent	URFA	Unfurnished rent free accommodation
ER	Expected rent	ICOI	Index cost of improvement
DA	Dearness allowance	ICOA	Index cost of Acquisition
T/O	Turnover	SC	Sale consideration
Er	Employer	TDS	Tax deducted at source
Ee	Employee	TCS	Tax Collection at source
FMV	Fair market value	GR	Gross Receipts
SDV	Stamp duty value	TI	Total Income

ABOUT THE BOOK

Master Income Tax with Ease – CA Vivek Gaba's Crux Book for May 2025 & Onwards!

Are you preparing for the taxation exam and looking for a book that simplifies complex concepts while ensuring maximum retention?

Look no further! Income Tax Crux Book for May 2025 & Onwards by CA Vivek Gaba is your ultimate guide to success.

Designed with a student-friendly approach, this book condenses the vast syllabus into just 30 pages, making it the perfect tool for efficient and effective revision.

With a color coded system :-

- Blue for content
- Red for crucial points
- Green for amendments

It ensures clarity and focus on what truly matters. Whether you're struggling with intricate provisions or aiming for last-minute revision, this book provides the perfect balance of conceptual understanding and exam-oriented preparation. Stay ahead, stay confident, and master Income Tax effortlessly!

"Success is not about how much you read, but how well you understand and apply it!"

Chapter -1 Basic Concepts

Meaning of Tax

Tax is a **compulsory exaction** of money by public authority for public purpose, **enforceable by law**.

Meaning of Direct Tax

Tax which **levied on person burden on same person**.

Difference between Direct Tax & Indirect Tax

Basis	Direct Tax	Indirect Tax
Meaning	Levied/burden on same person	Levied/burden on different person
Nature	Progressive	Regressive
PY & Ay	PY income assessed in AY .	No concept of PY & AY.
Department	CBDT	CBIC
Taxable event	When Income arise.	Supply of goods or services or both.
Revenue distribution	CG	CG & SG as case may be.
Example	Income Tax, Gift Tax.	GST, Custom.

Constitution of Law

- ACT
- Rules
- Circular/Notification
- Case Law

Procedure -Formation of Law

Bill

Money Bill

1. Lok sabha
2. Rajya sabha
3. President assent

Ordinary Bill

Can be present first to either lok sabha or Rajya sabha.

ARTICLE 245,246,254

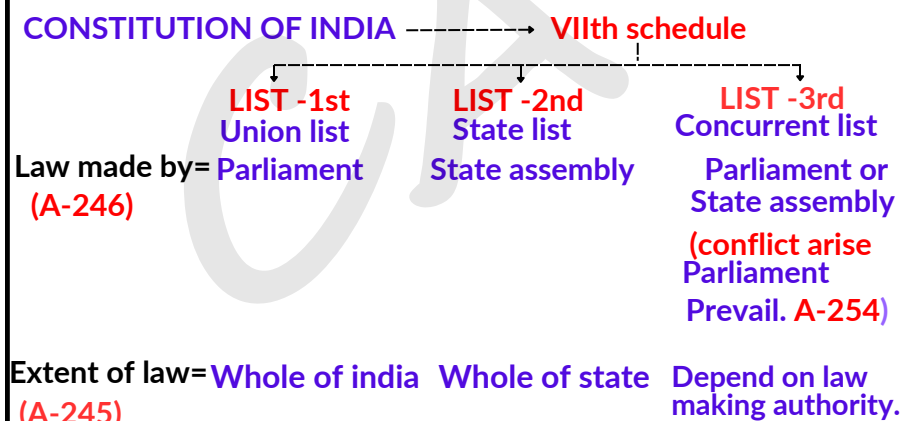

ENTRY NO. OF TAXATION

List -1		List -2		List -3
Entry no.	Name	Entry no.	Name	
82	Taxes on income other than agriculture income	46	Taxes on Agriculture Income	NO TAXATION
83	Custom duty			
84	Excise duty			
85	Corporate tax			

Article 246

No Tax shall be levied without authority of law.

Definition of India

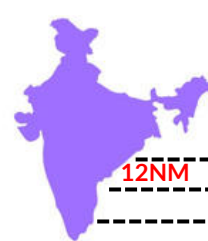

- Upto 12 notical miles from baseline :-For all purpose.
- Upto 200 notical miles from baseline:-For only oil and gas purpose.

Income Tax Act 1961

- Levy of Income Tax in India is governed by Income Tax Act 1961.
- It extends to **whole of india (Including J&K)**.
- It came into force on **1/4/1962**.
- It contains **298 Sections and XIV Schedule**.
- Ammendment through **Finance Act** every year.

Income Tax Rules 1962

- For proper **administration** of Income Tax Act ,CBDT frame rules from time to time they collectively called Income Tax Rules 1962.
- Rules **cannot override Act**.

Notifications

- To bring **change or remove or add** the provision in the middle of the year.
- Issued by CG or CDBT, Binding on department or assessee.
- **6 month before exam** are applicable for exam.

Circulars

- To **clarify doubts** regarding meaning of various provision ,CBDT issued circular which binding on department not to assessee.
- **6 month before exam** are applicable for exam.

Finance Act

- The Finance Bill, introduced by the Finance Minister, becomes the Finance Act after approval by Parliament and the President, amending tax laws like the Income-tax Act, 1961.
- In our exam **Finance Act 2024 is applicable** .

Case Laws

- Supreme Court and high court can give judgement only on the **question of law**.

Section 4 : Charging section of Income Tax

- **Every person**
- whose **Total income**
- **Exceeds** the maximum amount which is not chargeable to income tax
- Is an **assessee** and
- Chargeable to income tax at **rate or rates prescribed in the finance Act** for the relevant previous year.

person [Section 2(31)]

Person include

- An individual (**All types of individual**).
- Hindu undivided family (**Muslim & Christian not cover**).
- Company (**Indian co. ,Foreign co.**)
- AOP or BOI
- Firm **include LLP**
- Local authority, Cooperative society
- Every artificial judicial person not cover in above clause.

Assessee [Section 2(7)]

Assessee: A person **liable to pay tax** or any other sum under the Act Includes:

- Persons for whom **tax assessment** is done (on their income, others' income, or loss).
- Persons entitled to a **tax refund**.
- Persons **deemed an assessee** under specific provisions of the Act.
- Persons **deemed to be in default** as per the Act.
- Every assessee is a "person," but not every "person" is an assessee.

Chapter -1 Basic Concepts

Total Income and Tax Payable

$$\text{Income Tax Liability} = \text{Total Income} \times \text{Tax Rates}$$

Step 1 :- Determine of Residential status

- Total income of an assessee is based on the residential status of an assessee.
- Residential status → R → ROR
NR → RNOR

Step 2 :- Classification of Income under different heads

- Income arise from unlimited sources but distributed into 5 heads of Income.
 - Salary [sec 15 to 17]
 - House property [sec 22 to 27]
 - PGBP [sec 28 to 44DB]
 - Capital gains [sec 45 to 55A]
 - Other sources [sec 56 to 69]

Step 3 :- Computation of Income under each heads of Income

Step 4 :- Clubbing of the Income of spouse, son's wife, minor child etc.

Step 5 :- Setoff or carry forward of losses

Step 6 :- Gross Total Income

Step 7 :- Deduction from Total Income

- Deduction under VIA
- Deduction under 10AA

Step 8 :- Computation of Total Income

Step 9 :- Rounding off of Total Income

- In multiple of ₹10 (last digit < 5 =last 10),(last digit ≥ 5=next 10)

Step 10 :- Application of Tax rates and compute Tax

- Normal rates → Default Scheme u/s 115BAC
- Special rates → Optional Scheme (F ACT)

Step 11 :- Applicability of surcharge or rebate on above tax liability

Step 12 :- Health and education cess on Income Tax

Step 13 :- Alternate minimum tax (AMT)

- Applicable on when opt for optional scheme
- Tax payable=Higher of AMT or Tax under optional scheme.

Step 14 :- Examine whether to pay tax under the default tax regime or optional regime

Step 15 :- Deduction of TDS/TCS or Advance Tax

Step 16 :- Tax Payable/Tax Refundable

Step 17 :- Rounding off of Final Tax

- In multiple of ₹10 (last digit < 5 =last 10),(last digit ≥ 5=next 10)

Step 18 :- Payment to govt if tax payable through Return of Income

Definition of Previous year & Assessment year

PY (sec 3)	AY (sec 2g)
1. The year in which Income is earned.	1. The year in which Income is chargeable to tax.
2. It may be 12 month or less than 12 month.	2. It may be always 12 month.
3. It start from date of setup.	3. It always start from date 1st April,
4. For may/june/Sep/Dec 25, PY 24-25 is relevant.	4. For may/June/Sep/Dec 25, AY 25-26 is relevant.

Cases when income of PY will assessed in PY itself

- Shipping business of non resident.
- Person leaving India.
- AOP/BOI/Artificial judicial person formed for a **particular event or purpose.**
- Person likely to transfer property to **Avoid tax.**
- Discontinued business.**

Health & Education cess on income tax

4% H&E cess applies to All taxpayers on income tax, funding Healthcare and education initiative.

Default tax regime u/s 115 BAC of IT ACT 1961

- Other names= Concessional scheme, New regime

Applicability = Individual, HUF, AOP, BOI, AJP
(Whether R or NR irrespective of age)

Total Income	Rate
Upto ₹3,00,000	NIL
₹3,00,010 - ₹7,00,000	5%
₹7,00,010 - ₹1,00,00,000	10%
₹10,00,010 - ₹12,00,000	15%
₹12,00,010 - ₹15,00,000	20%
₹15,00,010 (i.e more than)	30%

Surcharge under default Tax regime

Total Income	Rate
Upto ₹50,00,000	NIL
>₹50,00,000 - ₹1,00,00,000	10% of tax
>₹1,00,00,000 - ₹2,00,00,000	15% of tax
>₹2,00,00,000	25% of tax

Marginal relief

Particular	Amount
[A] Compute income tax including surcharge on Total income	xxx
[B] Compute Income tax on 50L/1cr/2cr	xxx
[C] Excess tax payable (A-B)	xxx
[D] Marginal relief(Tax increment > Income increment)	xxx
[E] Tax liability (A-D)	xxx
Add:- Health & Education cess	xxx
Tax liability (Including cess)	xxx

Rebate under 87A

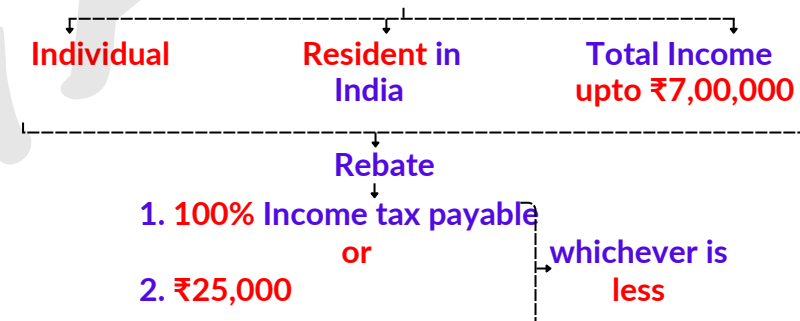

What if total income more than ₹7,00,000?

Step	Process	Amount
Step 1	[A] Total income (-) ₹7,00,000	xxx
Step 2	[B] Compute Tax liability on Total income	xxx
Step 3	[C] If B>A, rebate = B(-)A	xxx

Important points

- Tax liability is less than increase in income exceed ₹7,00,000 **No rebate allowed.**
- Rebate allowed **before adding 4% H&E cess.**
- No rebate is allowed for **LTCG u/s 112A.**
- No rebate is allowed **unexplained money.**

Chapter -1 Basic Concepts

If assessee opt default scheme u/s 115BAC then he has to forego following exemptions or deduction

- Salary
 - Sec 10(5) - leave Travel Concession (LTC)
 - Sec 10(13A) - House rent allowance (HRA)
 - Sec 10(14) - Special Allowance (13 Approx) **Except** daily allowance, traveling Allowance, conveyance allowance, transport allowance (**handicapped**)
 - Sec 16(ii) - Entertainment Allowance
 - Sec 16(iii) - Professional Tax
 - Perquisites - Free meal upto ₹50 (lunch facility)
- House property
 - Sec 24(b) - Interest on loan in respect of self occupied house
- PGBP
 - Sec 10AA - Deduction in respect of SEZ
 - Sec 32(1)(iia) - Additional Depreciation
 - Sec 35(1)(ii) - Deduction to specified approved institute
 - Sec 35(1)(iia) - Deduction in respect of contribution/Payment to comply registered in India
 - Sec 35(1)(iii) - Donation to specified institute for social science or statistical research.
 - Sec 35(2AA) - Donation or payment to IIT for scientific research.
 - Sec 35AD - Donation/Deduction in case of essential business
 - Sec 35CCC - Expenditure on agriculture extension.
- Capital gain
 - No Impact
- Other source
 - No Impact
- Clubbing of income
 - Exemption of ₹1500 per child in respect of minor child.
- Setoff & Carry forward of losses
 - House property can't be set off with any other head of income & can't be c/f
 - Unabsorbed depreciation related to additional depreciation can't be setoff
- Deduction
 - All deduction u/s VI-A (Sec 80C to 80U) not allowed **Except 80CCD(2), 80CCH(2), 80JJAA.**
- Other Important point
 - Sec 10(17) - Allowance to MP/MLA

Time limit for opting out of default regime

- No Business Income: Can opt out every year PY while filing returns.
- Having Business Income : Assessee exercise regular scheme only once for PY, there after person shall never be eligible for the benefit of regular tax regime till the time having any income under PGBP

AMT liability not attracted

Person paying tax under **default tax regime** u/s 115BAC is **not liable** to AMT such person would **not eligible** to claim AMT credit also.

Optional Tax Regime

- Other names :-
- Normal scheme
 - Shift-out/opt-out from default scheme
- Applicability:- Individual /huf/AOP/BOI/AJP

Tax rate for individual

Resident in india

Age <60		Age >=60 <80		Age >=80 <∞	
Total Income	Rate	Total Income	Rate	Total Income	Rate
Upto 2,50,000	NIL	Upto 3,00,000	NIL	Upto 5,00,000	NIL
2,50,000-5,00,000	5%	3,00,000-5,00,000	5%	—	—
5,00,000-10,00,000	20%	5,00,000-10,00,000	20%	5,00,000-10,00,000	20%
10,00,000 or more	30%	10,00,000 or more	30%	10,00,000 or more	30%

Non resident

Total Income	Rate
Upto ₹2,50,000	NIL
₹2,50,000 - ₹5,00,000	5%
₹5,00,000 - ₹10,00,000	20%
₹10,00,000 or more	30%

- Same rate for all ages.

Important point

- 60 year or more = At any time during the PY
- 80 year or more = At any time during the PY
- If DOB 1/4/1945 = **Demeed 80 year on 31/3/25**
- If DOB 1/4/1965 = **Demeed 60 year on 31/3/25**

Surcharge under Optional Tax regime

Total Income	Rate
Upto ₹50,00,000	NIL
>₹50,00,000 - ₹1,00,00,000	10% of tax
>₹1,00,00,000 - ₹2,00,00,000	15% of tax
>₹2,00,00,000 - ₹5,00,00,000	25% of tax
>₹5,00,00,000	37% of tax

Marginal relief

Same as default tax regime

Rebate under 87A

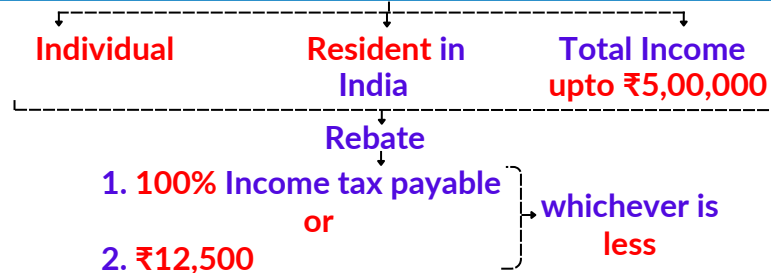

What if total income more than ₹5,00,000?

- No rebate after ₹5,00,000 normal tax rate apply.

Important points

- Rebate allowed **before adding 4% H&E cess.**
- No rebate is allowed for LTCG u/s 112A.
- No rebate is allowed **unexplained money.**

Tax rate in case of HUF,AOP,BOI,AJP

Total Income	Rate
Upto ₹2,50,000	NIL
₹2,50,000 - ₹5,00,000	5%
₹5,00,000 - ₹10,00,000	20%
₹10,00,000 or more	30%

- Surcharge, MR concept are same as case of individual.

Special Income tax rate under IT ACT 1961

Applicability: All assessee (Individual, huf, AOP, BOI, AJP, company)

Scheme:- Any scheme (optional or default)

Sec	Income	before 23/7/24	on or after 23/7/24
112	Long term capital gain(LTCG)	20%	12.5%
112A	Long term capital gain(LTCG)	10%	12.5% in excess of 1,25,000
111A	Short term capital gain(STCG)	15%	20%
115BB	Wining from lottery, horse race, puzzle, card games etc.	30%	30%
115BBJ	Net wining from online games	30%	30%
115BBE	Unexplained money, investment	60%	60%
115BBG	Carbon credit income	10%	10%

- LTCG 112A :- Taxable in excess of 1,25,000. **Aggregate limit** for whole year. **No manner** prescribe use of 1,25,000 (preferable 12.5%)
- Deduction u/s VI-A **not allowed** to above special income

Treatment of surcharge

Total income includes only other income	Total income includes only special income	Total income includes other income & special income																				
Other income means other than <ul style="list-style-type: none"> • LTCG u/s 112 • LTCG u/s 112A • STCG u/s 111A • Dividend income 	Special Income means <ul style="list-style-type: none"> • LTCG u/s 112 • LTCG u/s 112A • STCG u/s 111A • Dividend income 	<table border="1"> <thead> <tr> <th>Total income</th> <th>Rate</th> </tr> </thead> <tbody> <tr> <td>upto 50 lakh</td> <td>nil</td> </tr> <tr> <td>>50 lakh-1 crore</td> <td>10%</td> </tr> <tr> <td>>1 crore -2 crore</td> <td>15%</td> </tr> <tr> <td>>2 crore</td> <td>25%</td> </tr> </tbody> </table>	Total income	Rate	upto 50 lakh	nil	>50 lakh-1 crore	10%	>1 crore -2 crore	15%	>2 crore	25%										
Total income	Rate																					
upto 50 lakh	nil																					
>50 lakh-1 crore	10%																					
>1 crore -2 crore	15%																					
>2 crore	25%																					
<table border="1"> <thead> <tr> <th>Total income</th> <th>Rate</th> </tr> </thead> <tbody> <tr> <td>upto 50 lakh</td> <td>nil</td> </tr> <tr> <td>>50 lakh-1 crore</td> <td>10%</td> </tr> <tr> <td>>1 crore -2 crore</td> <td>15%</td> </tr> <tr> <td>>2 crore</td> <td>25%</td> </tr> </tbody> </table>	Total income	Rate	upto 50 lakh	nil	>50 lakh-1 crore	10%	>1 crore -2 crore	15%	>2 crore	25%	<table border="1"> <thead> <tr> <th>Total income</th> <th>Rate</th> </tr> </thead> <tbody> <tr> <td>upto 50 lakh</td> <td>nil</td> </tr> <tr> <td>>50 lakh-1 crore</td> <td>10%</td> </tr> <tr> <td>>1 crore -2 crore</td> <td>15%</td> </tr> <tr> <td>>2 crore</td> <td>15%</td> </tr> </tbody> </table>	Total income	Rate	upto 50 lakh	nil	>50 lakh-1 crore	10%	>1 crore -2 crore	15%	>2 crore	15%	<ul style="list-style-type: none"> • Tax on special income =15% • If other income upto 2cr =15% • if other income more than 2cr =25%
Total income	Rate																					
upto 50 lakh	nil																					
>50 lakh-1 crore	10%																					
>1 crore -2 crore	15%																					
>2 crore	25%																					
Total income	Rate																					
upto 50 lakh	nil																					
>50 lakh-1 crore	10%																					
>1 crore -2 crore	15%																					
>2 crore	15%																					

Dividend income

- Tax :- Slab rate
- Surcharge:- $\frac{\text{Total tax on normal income}}{\text{Total income of normal income}} \times \text{Dividend income}$

Chapter -1 Basic Concepts

Treatment of balance exemption limit

Can be used by Individual or HUF AND Resident in india

Can be used in LTCG u/s 112 LTCG u/s 112A STCG u/s 111A

Important point

- Benefit **not available** for non resident.
- Balance can use for **maximum benefit** of assessee.

Crux of special income

	SI or tax Computation	SI for surcharge	SI for balance exemption limit	SI for Rebate
LTCG112	✓	✓	✓	✗
LTCG112A	✓	✓	✓	✓
STCG111A	✓	✓	✓	✗
Casual income	✓	✗	✗	✗
Dividend income	✗	✓	✗	✗

Tax rate in case of firm/LLP/Local authority

Total income = **flat 30%** (without any exemption limit)
 Surcharge = Upto 1 crore =NIL, More than 1 crore =12%

Tax rates in case of co-operative society

Normal scheme

Total income	Rate
Upto ₹10,000	10%
10,010 - 20,000	20%
20,010	30%

Surcharge

Total income	Rate
Upto 1 crore	NIL
>1 crore - 10 crore	7%
>10 crore	12%

Special Scheme

Sec 115BAD Tax =22% Surcharge =10% Cess =4%

Sec 115BAE Tax =15% Surcharge =10% Cess =4%

Effective rate=25.168

Effective rate=17.167

Tax rates in case of Company

Domestic company

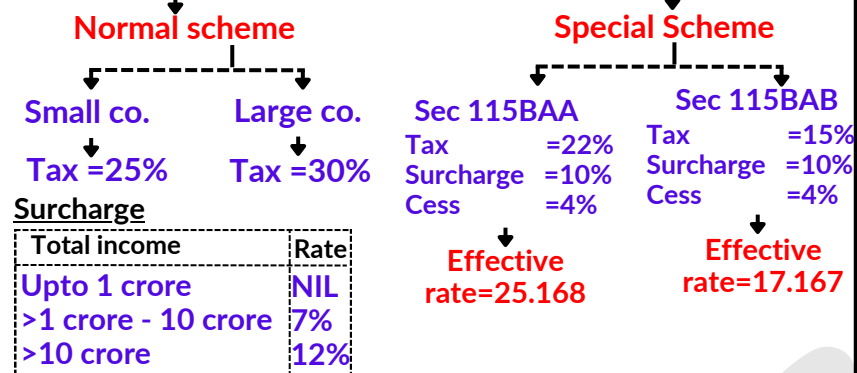

Foreign company

- Tax rate = 35% (in all income except Royalty)
- Royalty taxable = 50%

Surcharge

Total income	Rate
Upto 1 crore	NIL
>1 crore - 10 crore	2%
>10 crore	5%

Agriculture income taxation

Agriculture income :- It is **exempt** from tax if it is from agriculture land in India.

Agriculture income means :-

- Rent from agriculture land (used for agriculture purpose)
- Rent from house (use as dwelling house, store house)
- Income from nursery
- Income from sale of agriculture produce.(Note1)

Note 1:- Sale of agriculture produce

- Sale in raw form
 - wholly agriculture income
- Sale after process
 - Agriculture income

FMV of agri produce further process	xxx
Less : Cost of Agri produce	xxx
Agriculture income	xxx

b) PGBP

Sale of final product	xxx
Less : FMV of agri produce use	xxx
Less : Further process cost	xxx
PGBP	xxx

Income from growing manufacturing of rubber, coffee, tea

Rule	Apportionment of income in certain cases	Agriculture income	PGBP
7A	Growing&manufacturing of rubber	65%	35%
7B	Growing&manufacturing of coffee	75%	25%
	• Grown & cured		
	• Grown,cured,roasted & grounded	60%	40%
8	Growing&manufacturing of tea	60%	40%

Partial Integration of Agriculture income with non Agriculture income

Assessee is individual, AOP, BOI, HUF, AJP

Agriculture income is exceed ₹5,000

Non-agriculture income is more than basic exemption limit

If all condition satisfied

Tax Computation

- Step 1 : Add non-agriculture income with net agriculture income. Compute tax on the aggregate amount.
- Step 2 : Add net agriculture income and basic Exemption limit available to assessee . Compute tax on the aggregate amount.
- Step 3 : Step 1 (-) Step 2
- Step 4 : The sum arrived at shall be -
 - Increase by surcharge, if applicable,
 - Reduced by the rebate ,if any .
- Step 5 : Thereafter, it would be increase by H&E Cess.

Chapter -2 Residential Status

Section 6 :- Residential Status

Basic rules

- Residential Status determined **person separately**.
- Residential status determined for **previous year**.
- Person can be resident in **more than one country**.
- Citizenship & Residential Status **both are separate concept**.

General /Normal case

Individual

Total stay 182 days or more in R.P.Y

60 day or more and 365 days or more in 4 I.P.P.Y

Any one condition satisfied

Resident

Special case : 1

Individual who are Indian citizen leaves india as a member of crew of Indian ship in R.P.Y

Total stay 182 or more in R.P.Y

Resident

How to compute days stay in India?

Deemed o/s india = From the date of joining upto the date of signing off.

Important point

Date of arrival and date of departure

Both days considered to be **in India** except in case of member of crew.

Special case : 2

Individual who are Indian citizen leaves India for employment

Total stay 182 or more in R.P.Y

Resident

Special case : 3

Individual who are Indian citizen or of Indian origin settled o/s visit India and his total income other than foreign sources upto ₹15,00,000

Total stay 182 or more in R.P.Y

Resident

Special case : 4

Individual who are Indian citizen or of Indian origin settled o/s visit India and his total income other than foreign sources more than ₹15,00,000

Total stay 182 or more in R.P.Y

120 days or more and 365 days or more in 4 I.P.P.Y

Any one condition satisfied

Resident

Special case : 5

Individual who are Indian citizen his total income other than foreign sources more than ₹15,00,000

not liable to pay tax in any other country

Deemed resident in R.P.Y

How to compute T.I other than foreign sources

Particular	Include limit or not
1. Income arise in India.	Included
2. Income deemed to be arise in India.	Included
3. Income received in India.	Included
4. Income deemed to be received in India.	Included
5. Income arise outside India and received outside India but business controlled from India.	Included
6. Income arise outside India and received outside India but profession setup in India.	Included
7. Income arise outside India and received outside India and business controlled and profession setup outside India.	not Included

Residential Status of HUF/Company/AOP/BOI

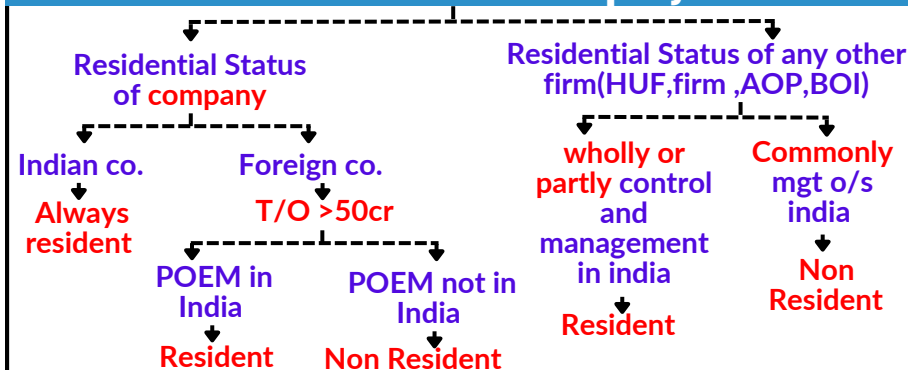

Taxability of interest, royalty & technical fees

Government	Other than govt
<ul style="list-style-type: none"> Interest paid Loan taken Royalty paid Know how Technical service 	<ul style="list-style-type: none"> Interest paid Loan taken Royalty paid Know how Technical service

← Outside india →

ROR/RNOR

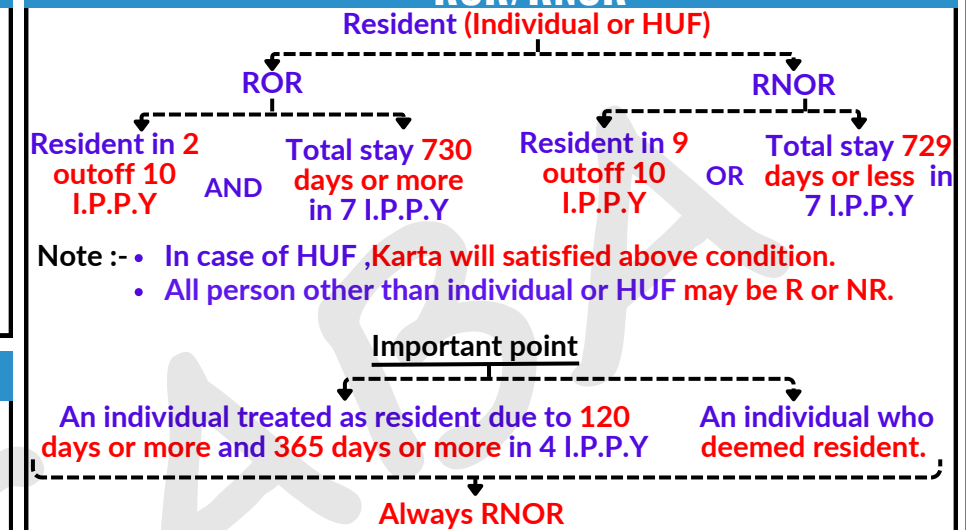

Scope of Total income/Meaning of Total inome

Particular	R/ ROR	R/ RNOR	NR
1. Income received in India [whether accure or arise in India or O/S india]	Taxed	Taxed	Taxed
2. Income deemed to be received in India [whether accure or arise in India or O/S india]	Taxed	Taxed	Taxed
3. Income accure or arise in India [whether received in India or O/S india]	Taxed	Taxed	Taxed
4. Income deemed to accure or arise in India[whether received in India or O/S india]	Taxed	Taxed	Taxed
5. Income received and arise O/S india from business control or profession setup in india.	Taxed	Taxed	Not taxed
6. Income received and arise O/S india from business control or profession setup O/S india	Taxed	Not taxed	Not taxed
7. Income arise and received O/S india later remittance in india.	Not Taxed	Not Taxed	Not Taxed
8. Post untaxed profit.	Not Taxed	Not Taxed	Not Taxed
9. Income exempt under any provision of IT ACT 1961.	Taxed	Taxed	Taxed

Income deemed to be accure or arise in India [Sec -9]

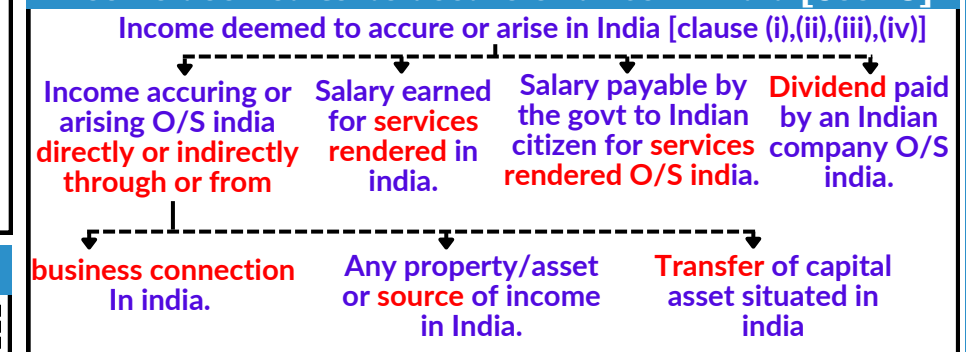

Chapter - 3 Salaries

Income from salary

Income from salary:- Sec-15 = Sec 17(+)+ Sec 10(-)+ Sec 16

Basic points kept in mind

- Employer & Employee **relationship exists**.
- **Income in hands** of Employee.
- Every payment made by Employer to Employee is **deemed as salary** in the hands of Employee.
- Employer & Employee relation not exist may be taxable under **any other head**.
- Employer expenditure on Employee treatment under **PGBP**.

Important point

Payment



Section 15 : Charging section

Salary shall be chargeable to tax



Section 15 (point 2) + Section 89(1)

Normally speaking, **Salary arrears** must be charged on **due Basis**, however there are some **circumstances** when it may not be **possible** to bring tax on **due Basis**.for eg:- pay commission by CG, increase in HRA.

Grade base salary

How to compute salary

Certain employee are entitled to a graded System normal **annual increment given**.

Example :-

Case -1 :- Joining date = 1/4/20
Joining salary = ₹25,000
Gross salary = 24-25 ?
Salary grade= 25000-1000-30000-500-32000

Case -2 :- Joining date = 1/1/20
Joining salary = ₹28000
Gross salary = 24-25 ?
GS= 30500×9 =274500 + 31000×3 = 367500

1/4/20-31/3/21	₹25,000	1/1/20-31/12/21	₹28,000
1/4/21-31/3/22	₹26,000	1/1/21-31/12/22	₹29,000
1/4/22-31/3/23	₹27,000	1/1/22-31/12/23	₹30,000
1/4/23-31/3/24	₹28,000	1/1/23-31/12/24	₹30,500
1/4/23-31/3/25	₹29,000	1/1/23-31/3/25	₹31,000

Gross salary = 30000×12 =360000

GS= 30500×9 =274500 + 31000×3 = 367500

Section 16 : Deduction from salary

Section 16(i) :- Standard Deduction
Section 16(ii) :- Entertainment Allowance Deduction
Section 16(iii) :- Professional tax / Employment tax Deduction

Important point

	Default Scheme	Optional Scheme
Section 16(i)	Allowed	Allowed
Section 16(ii)	Not allowed	Allowed
Section 16(iii)	Not allowed	Allowed

Section 16(i) : Standard deduction

Eligible employee:- **All employees** [whether govt,non-govt,big,small]

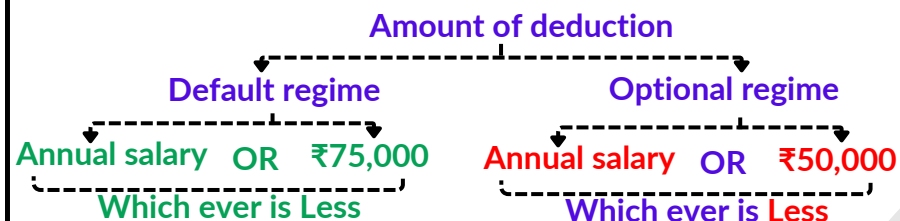

Section 16(ii) : Entertainment Allowance deduction

Eligible employee:- **Only Govt employee**

Scheme :- **Optional only**

Treatment :- 1st added in salary then allowed deduction as per section 16(ii)

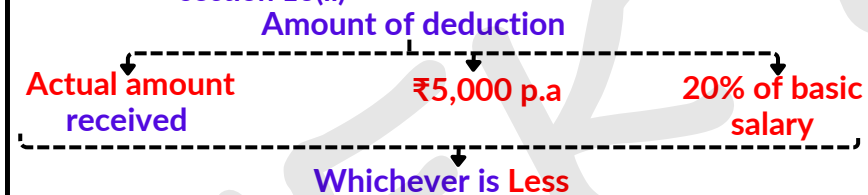

Important points

- Amusement allowance is **fully taxable** in all cases [govt,non-govt, default,optional]
- Entertainment Allowance fully taxable under **default scheme**.
- If question is silent about type of Employee we consider him as **non-govt employee**.

Section 16(iii) Professional tax/Employment tax

Eligible employee:- **All employee**

Scheme :- **Optional only**

Amount received form Employer	Add in salary
Amount paid by Employee	Deduction from salary

Amount received from employer	Amount paid by employer	Add in salary	Deduction u/s 16(iii)
500	800	500	800
800	500	800	500
500	NIL	500	NIL
NIL	800	NIL	800

Important points

- If question is silent then same amount would be add and same amount would be minus.

Employment tax paid = 500	500	500
---------------------------	-----	-----

Section : 10 Allowances & Retirement benefits

Allowances

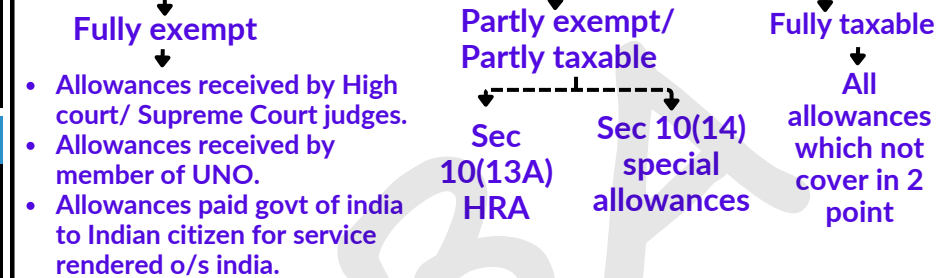

Section 10(14) : Special Allowances

Total 13 allowances

6 Allowances

CAT UDH

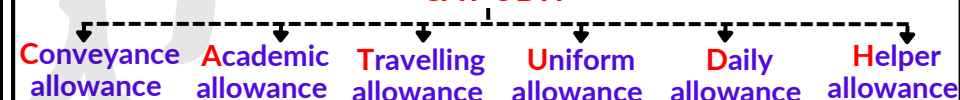

How to compute?

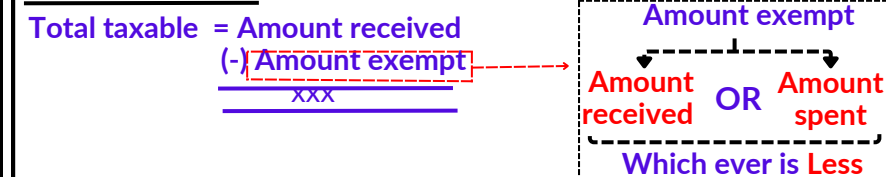

7 Allowances

CHOTU HaT

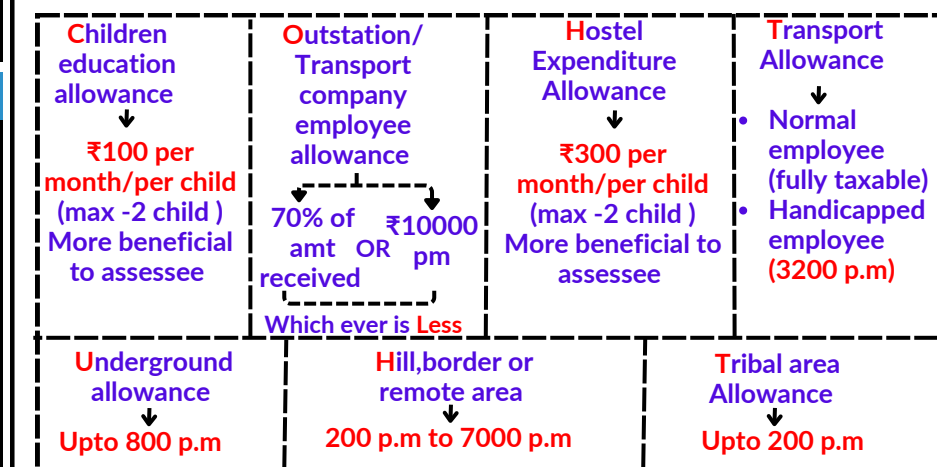

How to compute?

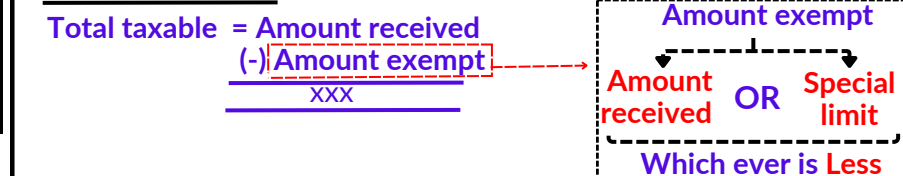

Chapter - 3 Salaries

Section 10(13A) : House rent allowance [HRA]

Scheme :- **Optional only**

$$\text{HRA taxable} = \text{HRA received} - \frac{\text{HRA exempt}}{\text{xxx}}$$

- a) Actual HRA received
- b) Rent paid (-) 10% of salary
- c) If metro city = 50% of salary
OR
Other city = 40% of salary

$$\text{Basic salary} + \text{Daerness allowance (DA) (UTOE)} + \text{Commission \% on basis of T/O Salary}$$

Important points

- Metro city=Delhi,Mumbai,Chennai, Kolkata.
- Exemption will be allowed only for the number of months for which **rent is paid**.
- If the employee is not paying the rent or not living in the rented apartment, then the **entire HRA received will taxable**.

Allowance Allowed to default regime us 115BAC

Partly exempt allowances

1. Daily Allowance
2. Travelling Allowance
3. Conveyance Allowance
4. Transport Allowance

Fully exempt Allowance

1. Allowances payable o/s india by govt of india to an Indian citizen for services rendered o/s india.

- Allowances other than above are **fully taxable under default scheme**.

Retirement benefit

1. Gratuity [sec 10(10)]
2. Pension [sec 10(10A)]
3. Leave Encashment [sec 10(10AA)]
4. Retirement compensation [sec 10(10B)]
5. Voluntary retirement services [sec 10(10C)]
6. Provident Fund

1. Leave Encashment [sec 10(10AA)]

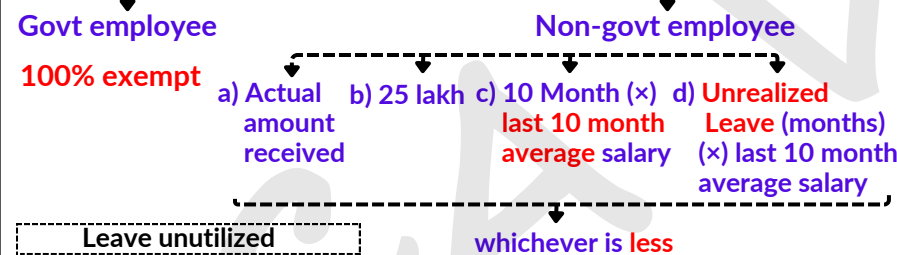

Leave unutilized	Salary Basic salary (+) DA (UTOE) (+) Comsn % on T/O
Total leave Allowed = xxx (-) Total leave taken = xxx	
Maximum leave allowed In month Actual or 30 days whichever is less	

2. Retirement compensation [sec 10(10B)]

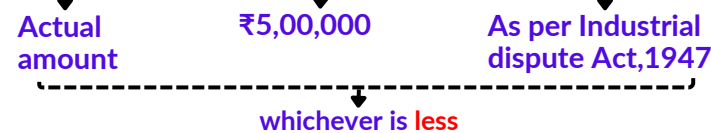

3. Gratuity [sec 10(10)]

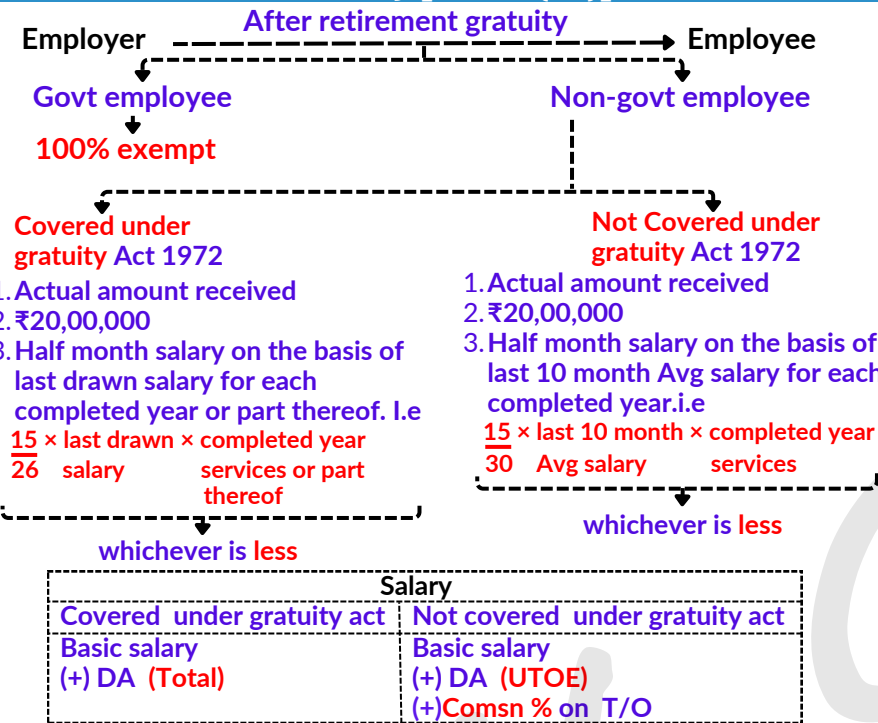

Important points

- Gratuity received **during service** are fully taxable.
- Gratuity received from 2 or more ER in same year, **maximum Exemption allowed ₹20,00,000**.
- Gratuity received from earlier employer or later from another employer [Exemption available = ₹20,00,000 (-) Earlier Gratuity].
- Exemption also available to **widow, children** of any deceased employee.
- Meaning of or part thereof:- upto 6 month not count, **more than 6 Month count 1 year**.

4. Pension [sec 10(10A)]

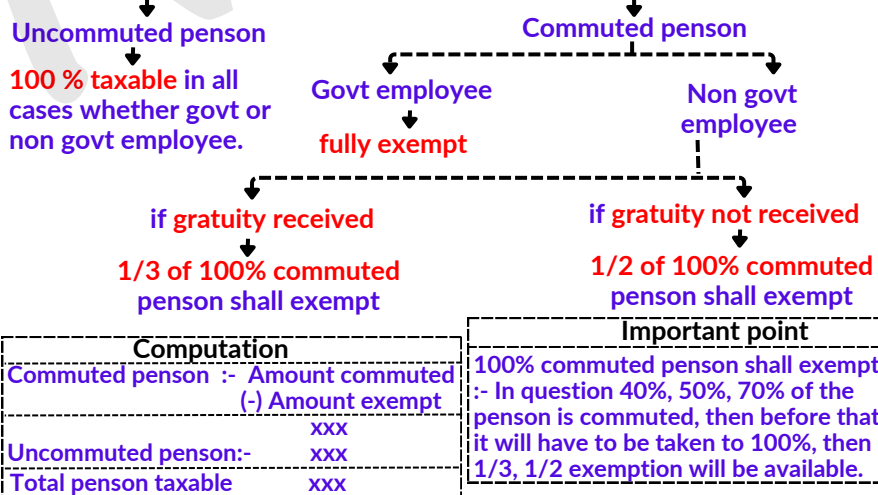

5. Voluntary retirement services [sec 10(10C)]

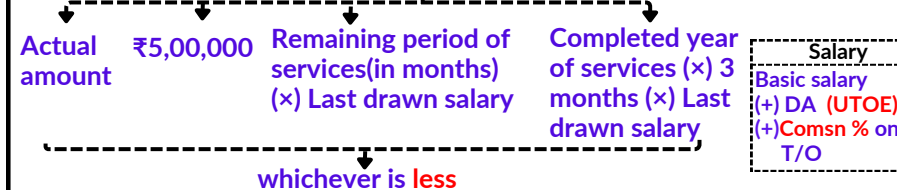

6. Provident fund

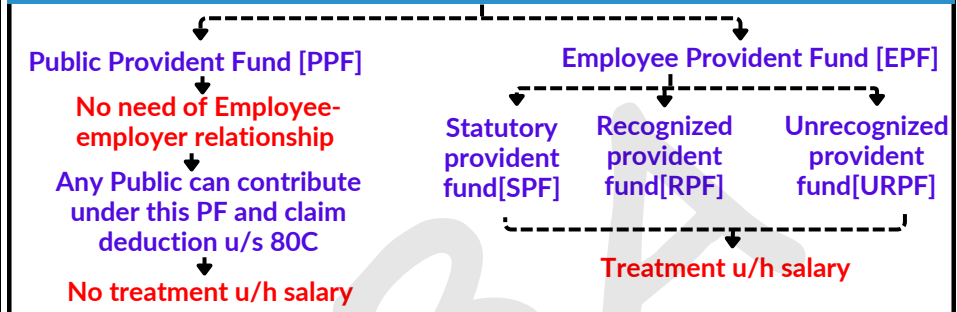

Exhaustive diagram of provident fund

	SPF	RPF	URPF
1) What will be the treatment of employee's contribution in the hands of the employee?	Taxable & eligible for deduction u/s 80C [subject to condition]	Taxable & eligible for deduction u/s 80C [subject to condition]	Taxable & not eligible for deduction u/s 80C
2) What will be the treatment of employer's contribution in the hands of the employee?	Fully exempt	<p>Employer contribution</p> <ul style="list-style-type: none"> Upto 12% of salary of Employee: If 12% contribution is upto ₹7,50,000 → Not taxable More than 12% of salary of Employee: If 12% contribution is more than ₹7,50,000 → Excess contribution taxable 	Not taxable (because treatment after retirement)
3) What will be the treatment of interest earned on employee's contribution in the hands of the employee?	<p>Contribution</p> <ul style="list-style-type: none"> Upto 2.5 lakh: Int accrued on such contri → exempt More than 2.5 lakh: Int accrued on excess contri → Now taxable 	<p>Contribution</p> <ul style="list-style-type: none"> Upto ₹2,50,000 & interest upto 9.5% on such contribution: exempt More than ₹2,50,000 & interest upto 9.5% on such contribution: Int on excess contri is taxable <p>If Int accrued on contri is more than 9.5% → Excess interest taxable</p> <p>If only employee is contribute Than limit of 2.5 Lakh increase to 5 lakh.</p>	Not taxable (because treatment after retirement)

Chapter - 3 Salaries

Provident fund :- Continue

4) What will be the treatment of interest earned on employer's contribution in the hands of the employee	Fully exempt (without any limit)	<p>Contribution</p> <ul style="list-style-type: none"> Interest upto 9.5% → Exempt Interest more than 9.5% → Excess interest taxable <p>But if employer contribution is more than ₹7,50,000 then interest on excess contribution shall also be taxable.</p> <p>How to compute taxable interest $Taxable\ portion = PC \times R + (PC1 + TP1) \times R$ PC = contribution in excess of ₹7,50,000 R = $\frac{I}{F.Avg}$ I = Interest accrued during PY $F.Avg = \frac{\text{Opening bal of Fund} + \text{Closing bal of Fund}}{2}$</p> <p>How to find out CL bal of Fund Op bal + er contri + ee contri + int = cl bal</p>	Not taxable (because treatment after retirement)
After retirement 5) Amount received on retirement	Fully exempt	Fully exempt (subject to condition)	<ul style="list-style-type: none"> Er contri Taxable Int on Er contri taxable Ee contri not taxable Int on ee contri Taxable u/h OS

Section 17 : perquisites under salary

1. Gift

Employer	Employee
Monetary form	Non monetary form
Fully taxable	<ul style="list-style-type: none"> Upto ₹5,000 → Exempt More than ₹5,000 → excess value taxable

2. Sweat equity share

Employer	Employee
Free of cost	Concessional rate
FMV on the date of issue of shares is chargeable to tax as perquisites.	FMV on the date of issue of shares less :- Amount paid by employee <u>Taxable perquisites</u>

3. LIC Premium

VOTP :- LIC premium borne by employer on behalf of employee

4. Lunch facility

Employer	Employee
It is exempt upto ₹50 per meal. If lunch is provided in office premises or through paid voucher.	
Important points	
<ul style="list-style-type: none"> Only allowed to optional tax regime. Tea, coffee or breakfast provided in office is not taxable. Lunch provided in remote area is not taxable. 	

5. Use of movable property

Mobile, laptop, computer etc.	Other movable property [AC, TC etc.]	
VOTP = NIL	Owned by Employer	Not Owned by Employer
	VOTP = 10% p.a of actual cost	VOTP = Actual charges
<ul style="list-style-type: none"> If laptop, mobile is use Personal work, VOTP = NIL (because it's nature is official) 		

6. Transfer of movable asset

Employer	Movable property transfer		Employee
Computer / laptop / mobile	Car	other any asset	
Taxable value WDV (-) consideration	Taxable value WDV (-) consideration	Taxable value WDV (-) consideration	
Dep @ 50% on WDV method [complete year]	Dep @ 20% on WDV method [complete year]	Dep @ 10% on SLM method [complete year]	

7. Sweeper, Gardner, watchmen / water, electricity, Gas etc

Own resources	Outside resources
Manufacturing cost / production cost / per unit	Actual charges incurred by Employer

8. Club membership / Credit card expenditure

Official purpose	Other purpose
VOTP = NIL	Actual expenditure incurred by Employer

9. Interest on loan

Employer	Employee
Free rate of interest	Concessional rate of interest
Rate charged by SBI on 1st day of the relevant PY is chargeable to tax as perquisites.	Rate charged by SBI on 1st day of the relevant PY less:- Amount paid by employee
Important points	
<ul style="list-style-type: none"> If loan is taken upto ₹20,000 are non taxable, or loan provided for special disease i.e aids, TB, cancer, Mental disorder are non taxable. 	

10. Leave Travel Concession [sec 10(5)]

Scheme :- Optional only	
The benefit is available to Individual citizen as well as in respect of travel Concession or assistance for him and his family.	
Family	
Spouse, children of individual and parents, brother, sister, of the individual wholly or partly dependent on the employee.	
Limit of exemption	
<ul style="list-style-type: none"> Exemption in respect of 2 journey performed in a block of 4 calendar year, where such LTC not availed by individual during any block of 4 calendar then one such unavailed LTC will carry forward for next block of 4 calendar year [Total 3 journey]. 	
Monetary limit [subject to shortest route]	
By air	Economy class fare exempt
By rail	First class fare exempt
By bus	delux class fare exempt
Important points	
<ul style="list-style-type: none"> In case of LTC is encashed without performing the journey then 100% amount received by employee would be taxable. The exemption shall not be available to more than 2 children of individual after 1 October 1998. This restriction shall not apply in respect of children born before 1 October 1998 and in case of multiple birth after a child. 	

11. Education facility

For employee	For children	For other relative
Fully exempt	<ul style="list-style-type: none"> own Institute / tie-ups Upto ₹1000 p.m/per child exempt excess amount taxable 	<ul style="list-style-type: none"> other wise Fully taxable

Chapter - 3 Salaries

12. Rent free accommodation/concessional(RFA)

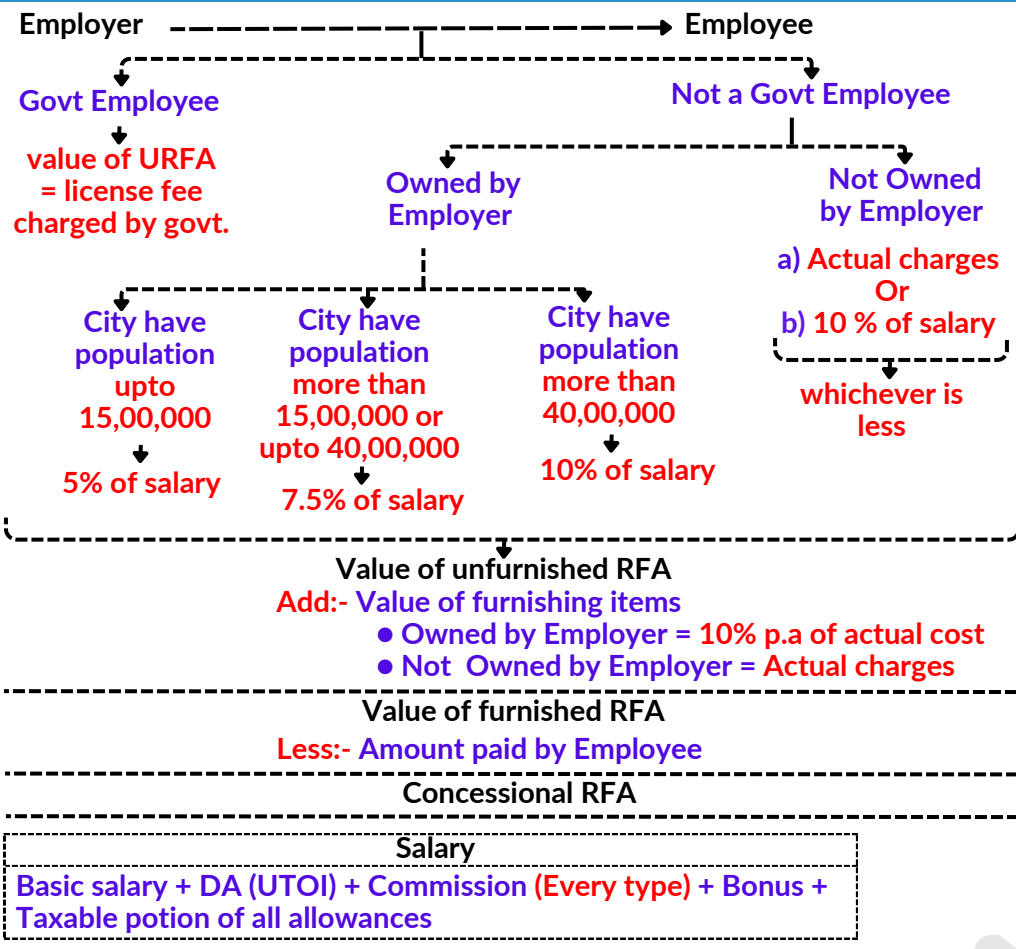

13. HOTEL FACILITY

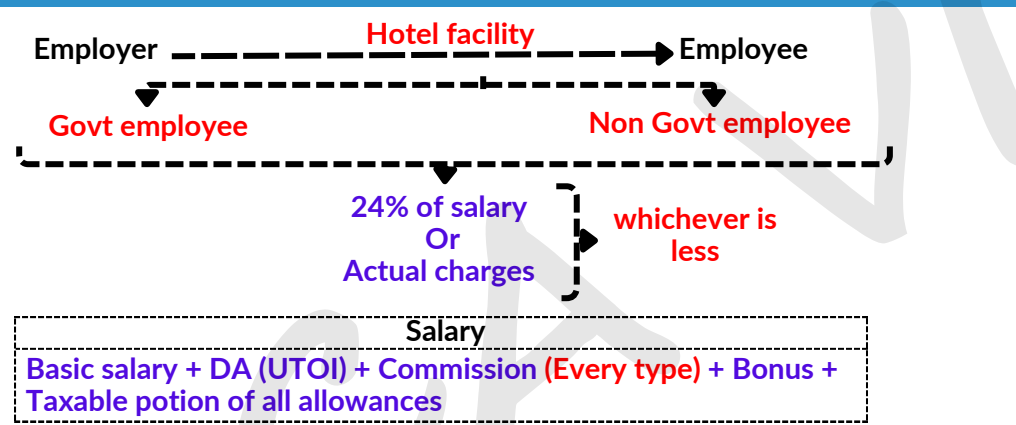

Important point related to RFA & Hotel facility

- Accommodation provided on account of his transfer from place to another, at the new place of posting while one retaining the accommodation at the other place, the value of perquisite shall be determined with reference to only one such accommodation which has the lower perquisite value for period Not exceeding 90 days and thereafter, the value of perquisite shall be charged for the both such accommodations.

Important point related to RFA & Hotel facility :- Continue

- However, Nothing shall be taxable if accommodation is provided for not more than 15 days and transfer of one employee from one place to another place.
- Value of Perquisite to be restricted to CII :- where the accommodation is owned or taken on lease or rent by the employer and the same accommodation is Continued to be provided to same employee for more than 1 year the value of perquisite as Calculated for more than 1 year ,the value of perquisite as Calculated for SI No.2 above shall Not exceed the amount so Calculated for the 1 PY as Multiplied By the amount which is a Ratio of the CII for the PY which the value is calculated.
- Employee serving on deputation: Where the accommodation is provided by the Central Government or any State Government to an employee who is serving on deputation with any body or undertaking under the control of such Government,-
 - the employer of such an employee shall be deemed to be that body or undertaking where the employee is serving on deputation; and
 - the value of perquisite of such an accommodation shall be the amount calculated in accordance with SI. No.2.(3) of the above point 3, as if the accommodation is owned by the employer.

14. Medical facility [Employee or family both]

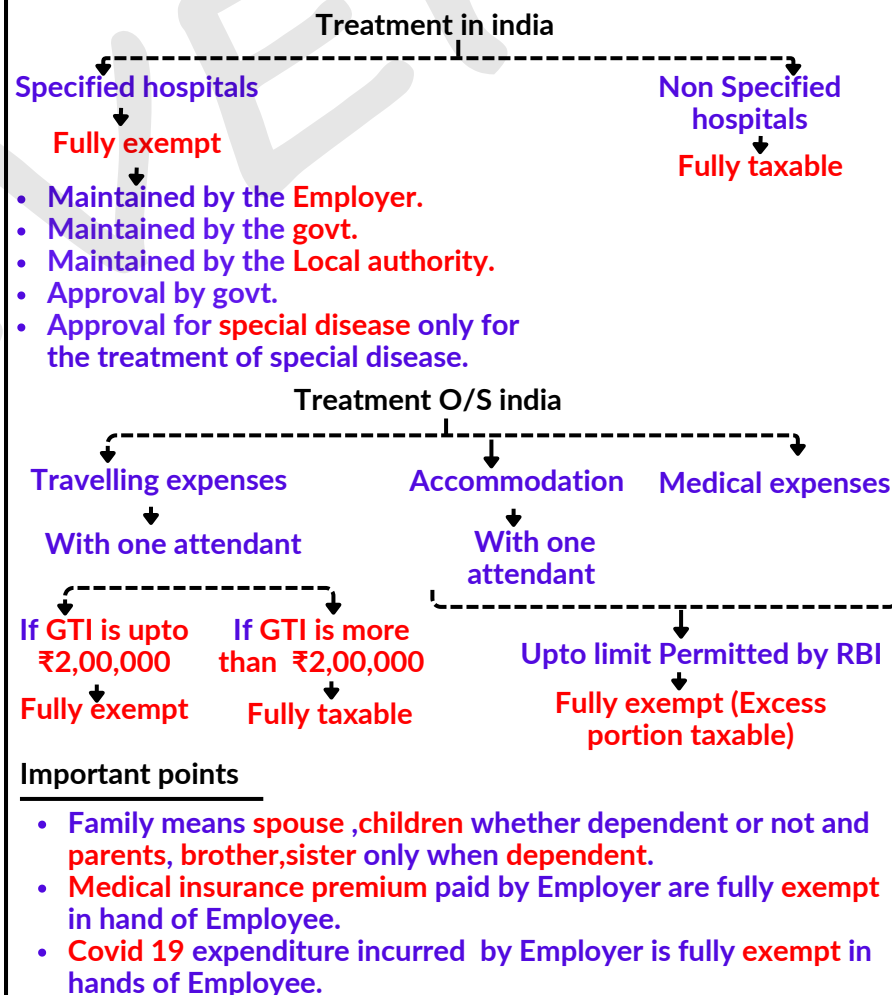

15. Motor car facility

Car owned by	Expenditure met by	Car used for 100% Personal purpose	Car used for both official and Personal purpose
Employee	Employee	NIL	NIL
Employee	Employer	Actual expenditure incurred by Employer.	Actual exp = xxx (-) Upto 1.6 ltr cc = 1800pm (-) More than 1.6 ltr cc = 2400pm (-) Driver. = 900pm VOTP = xxx [If actual expenditure is more than Specified limit then actual exp may reduced (after satisfaction of AO)]
Employer	Employee	10% of actual cost or Actual running and maintenance exp(if given)	Upto 1.6 ltr cc. = 600pm More than 1.6 ltr cc = 900pm (+) Driver. = 900pm VOTP = xxx
Employer	Employer	10% of actual cost + actual expenditure	Upto 1.6 ltr cc. = 1800pm More than 1.6 ltr cc = 2400pm (+) Driver. = 900pm VOTP = xxx

Employer contribution to RPF,NPS,SAF

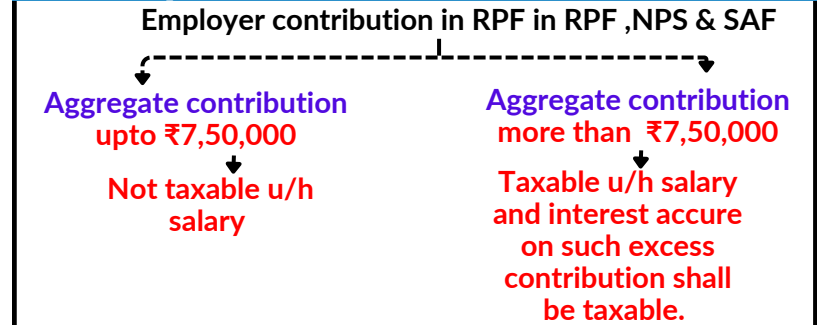

How to compute taxable perquisites

$$\text{Taxable perquisites} = \left(\frac{PC \times R}{2} \right) + (PC1 + TP1) \times R$$

Here,

- PC = Amount in excess of ₹7,50,000
- R = $\frac{I}{F.Avg}$
- I = Interest accrue during PY
- F.Avg = $\frac{OP \text{ bal of fund} + CS \text{ bal of Fund}}{2}$
- PC1 = Amount in excess of ₹7,50,000[related to last year]
- TP1 = Taxable perquisite[Computed in last year]

How to compute interest [if not given in question]

Closing balance of fund	
(-) Op bal of fund	
(-) Employer contribution	
(-) Employee contribution	
<u>Interest Income accrued</u>	

Chapter - 4 Income from house property

Background of house property

- Rental income:-
- Not a business of letout
 - Business of letout of residential property } HP
 - Business of letout of commercial property } PGBP
- Income from sale of HP
- Business of sale of HP } PGBP
 - Not a business of sale of HP } CG

Section 22 : Charging section

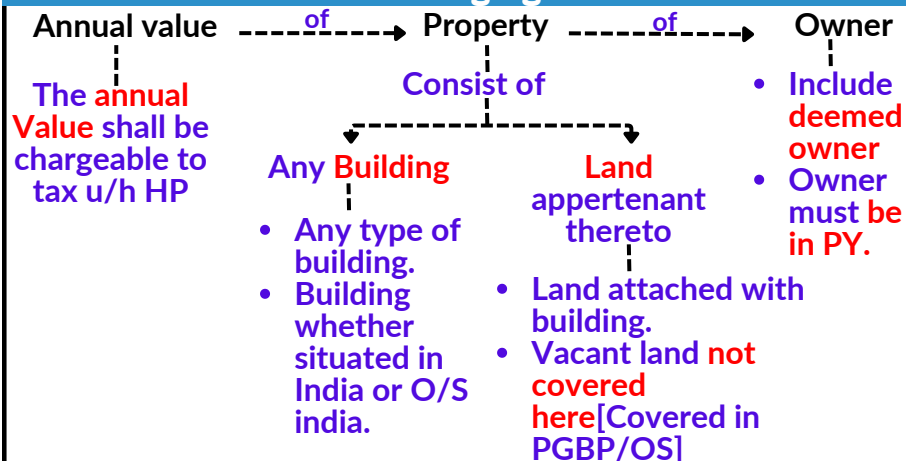

Exception of section 22

- Occupy for business or profession.
- Letout is supplementary to the main purpose.
- Composite rent
 - Inseparable - PGBP
 - Separate - building- HP
 - Furnish item - PGBP

Computation of Income from house property

Particular	Amount
Gross annual value [GAV]	xxx
Less :- Municipal tax paid by owner during the PY	(xxx)
Net annual value [NAV]	xxx
Less :- Deduction u/s 24	(xxx)
- Standard Deduction u/s 24(a)	(30% of NAV)
- Interest on housing loan u/s 24(b)	(xxx)
Income from house property	xxx
Add :- Recovery of unrealized rent/arrears of rent	xxx
Subject to condition	
Net income from house property	xxx

Deduction of Municipal tax

- Municipal Tax paid by owner ,or
- During the previous year.

Municipal tax paid by owner	✓
Municipal tax paid by tenant	✗
Municipal Tax Payable by owner	✗
Municipal tax payable by tenant	✗
Municipal tax burn by owner	✓

How to compute Gross annual value

GAV	Reasonable rental value.
FRV	Rent of similar building in same locality.
MV	Determine by municipality purpose of charging tax.
SR	Highest possible rent as per rent contract Act.
AR	Actual rent received.

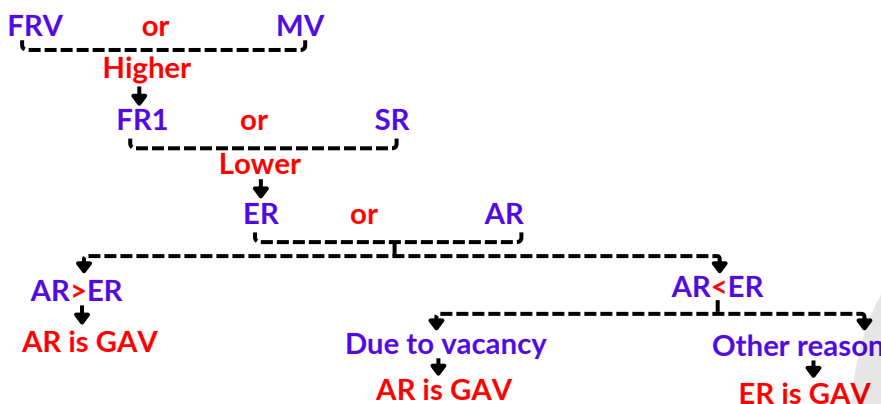

Case were GAV not to be Compute

- Wholly self Occupied
 - Wholly vacant house
 - Deemed self occupied
- Important point :-
- Option to take GAV NIL of self occupied house is available only for 2 house after that deemed letout.
 - GAV is NIL than municipal tax is only allowed to vacant house.

Section 23(5) :- House property held as stock in trade

- Business of purchase/sale [means SIT]
- Upto 2 years - vacant-GAV NIL.
- After 2 years-deemed letout-taxable u/h HP.

Section 24 : Deduction from annual value

Section 24(a) : Standard Deduction



Section 24(b) : Standard Deduction

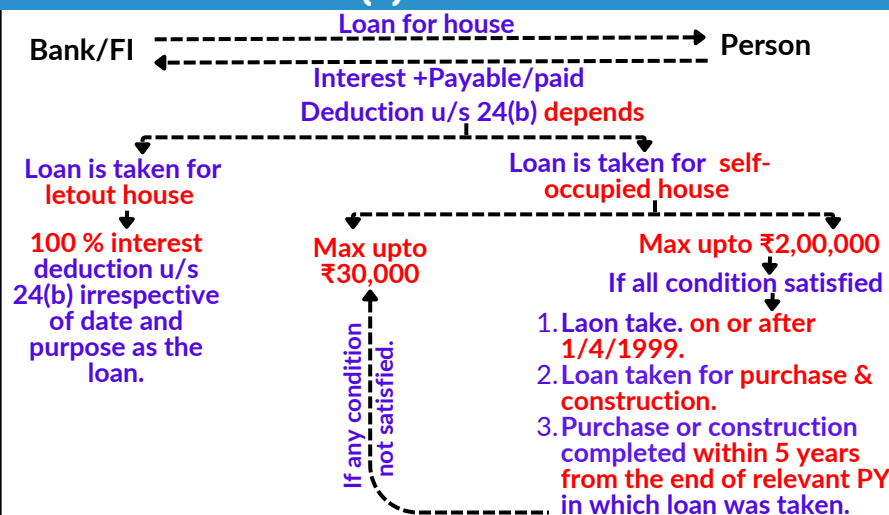

Important points for 24(b)

- Loan may taken from bank, family, friend, trust etc.
- Interest paid on due Basis allowed or outstanding interest allowed also allowed.
- Interest on interest [penal interest] are not allowed.
- New loan taken for repay earlier HP loan, Interest of new laon is allowed.
- Interest Paid o/s india if tds not deducted, not allowed.
- Deduction is ownerwise, not house wise.
- MAX deduction under SOH is ₹2,00,000
- In case of SOH If the interest is more than Rs 2,00,000 then deduction will be available u/s 80EE and 80EEA if the conditions are satisfied
- Pre-construction/Acquisition interest [note 1]

Pre-construction/Acquisition interest

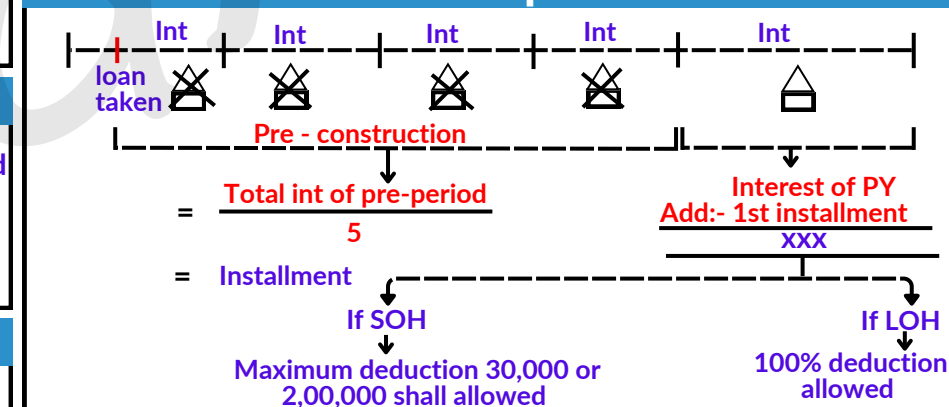

Benefit not allowed to Default regime u/s 115BAC

- Interest on house loan for SOH or deemed SOH u/s 24(b).
- Set-off of HP loss(letout/SOH) cannot be Set-off against any other head and can't be carry forward.

Section 25A : Recovery of unrealized rent & Arrear of rent

- Taxable in the year of receive/realisation.
- Deduction @30% of rent received / realized.
- Taxable even if assessee is not the owner of the property in the FY of receipt/realization.

Section 26 : Co-ownership/joint ownership

Joint ownership means property as owned by more than one owner, in this case income from house property is calculated normally, and thereafter it should be divided between co-owers in their ownership Ratio.

Interest on loan :- LOH/deemed LOH = Full interest allowed
:- SOH = ₹30,000/₹2,00,000 (x)no. of owner.

Section 27 : Deemed ownership

- Transferor gifting property to spouse or minor child (except married daughter).
- Holder of an impartible estate.
- member of co-operative society.
- Person in possession of a property.
- Person having right in a property for a period not a less than 12 years.

Chapter -5 PGBP

Flow of PGBP chapter/How to read PGBP chapter

Sec	Provision	Analysis
28	Charging section	Which Income will be taxable u/h PGBP
29	Computation of PGBP Income	How will the taxable Income be calculated?
30-38	Expenditure allowed	Expenses debit in P&L
39	Not relevant	
40	Expenditure disallowed	Expenses not debit in P&L
41	Recovery of expenditure allowed earlier	What will be the treatment if expenses which already allowed are recovered.
42	Not relevant	
43	Deduction on payment basis	Expenditure which will be debited will be on paid basis.
44	Presumptive taxation	For small business, professional

Section 28 : Charging section

Following income shall be taxable under the head PGBP:-

- Any profit or gain of any **Business /profession**.
- Profit on sale of Import entitlement license (IEL).
- Cash compensatory support or duty drawback (CCS/DDK).
- Profit on sale of duty entitlement pass book (DEPB) or duty free replenishment certificate (DFRC).
- Any amount received under **key man Insurance policy**.
- Any **gift/benefit/perquisite** due to business or profession (without exemption limit).
- Any **interest, Salary, bonus, commission**, received by partner from partnership firm to the extent allowed u/s 40(b) to firm.
- Non- competed fees**.
- Profit on sale of **carben credit** shall be chargeable to tax @10% u/s 115BBG.
- Income derived by a trade, professional or similar association from **specific service** performed by its member.
- FMV of inventory** as on the date on which it is converted into capital asset clause(VI-A)[**Net taxable income = FMV-COST**].
- Any compensation or other payment due to or received by any person or connection with **termination or modification** of the terms and conditions of any contract relating to his business.

Section 29 : How to compute PGBP income

Particular	Amount
Net profit as per P&L A/c of company's Act	xxx
Add : Expenditure debited in P&L A/c but not allowed u/h PGBP	xxx
Less : Expenditure allowed u/h PGBP but not debited in P&L A/c	(xxx)
Add : Income chargeable to tax u/h PGBP but not credited in P&L A/c	xxx
Less : Income credited in P&L A/c but not Taxable u/h PGBP	(xxx)
Income from PGBP	xxx

Type of expenditure

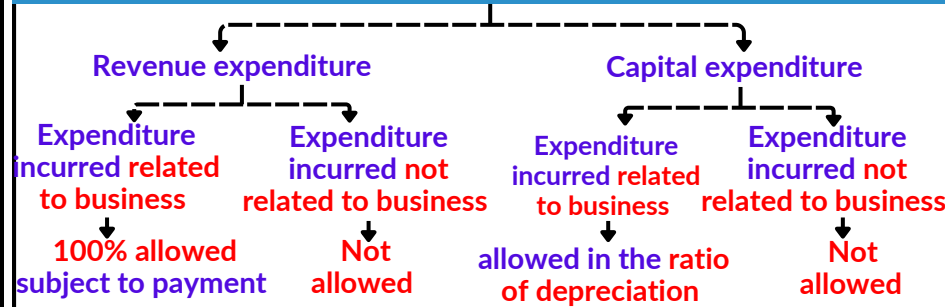

Section 30 & 31 : Expenditure related to building & machine & furniture

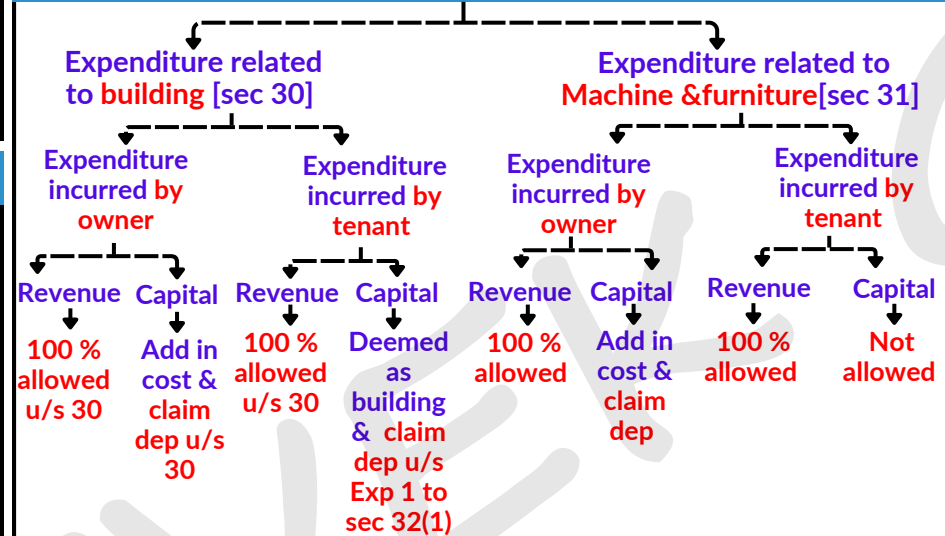

explanation-1 to section 32(1) :- Capital expenditure by tenant/ lessee such expenditure deemed as building and claim depreciation on such expenditure.

Section 32 : Depreciation

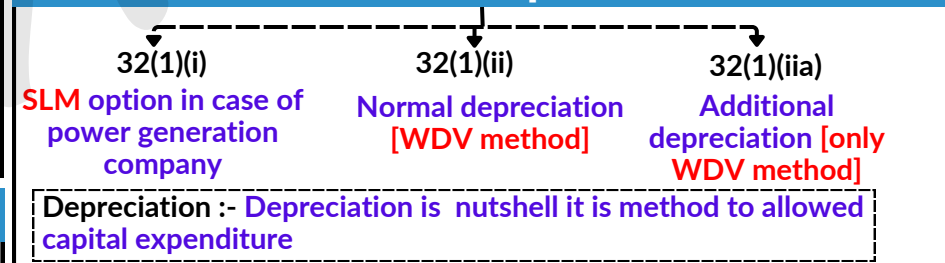

Section 32(1)(ii) : Normal Depreciation

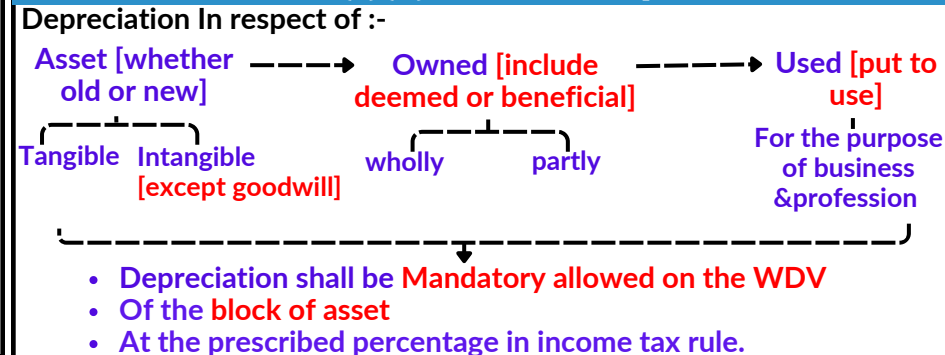

Method of Depreciation

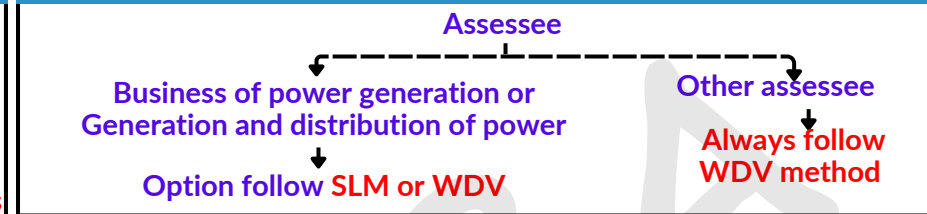

System of depreciation

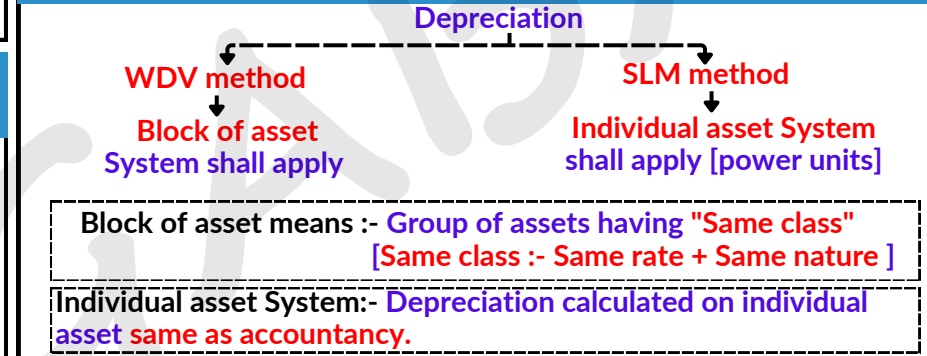

Type of depreciable asset

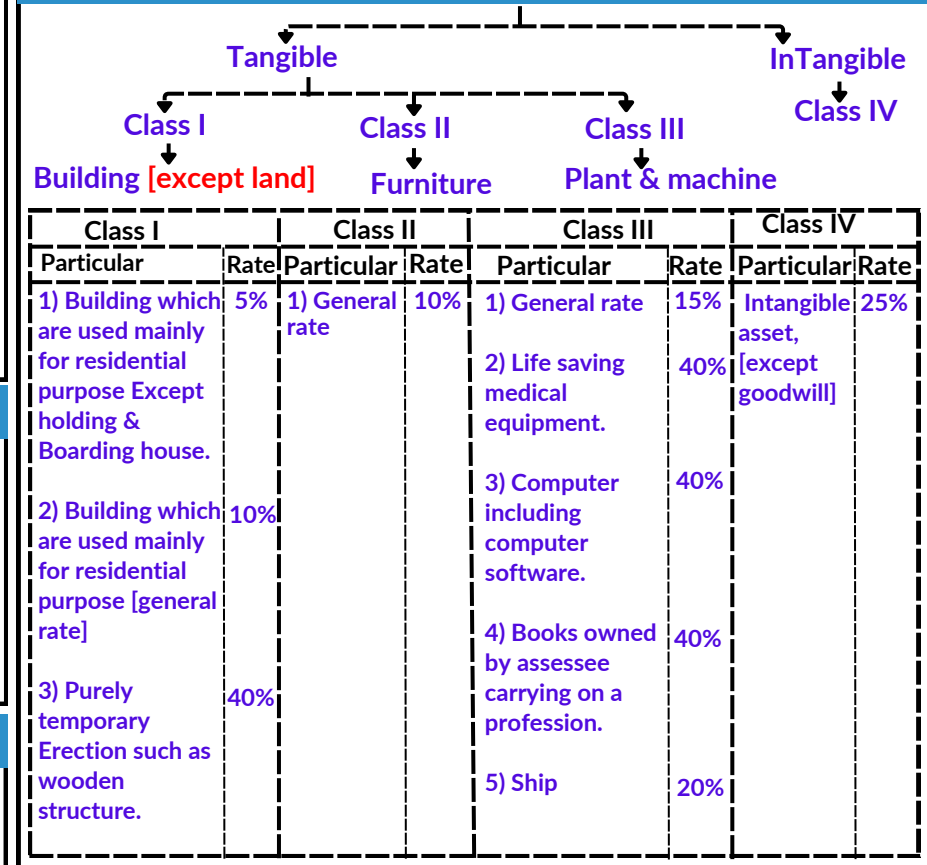

Chapter -5 PGBP

Proviso to Section 32(1)

Assets put to use in year of acquisition less than 180 days depreciation shall be restricted to 50% or depreciation allowed.

Cases	Depreciation
1. Purchase & Put to use in same year [put to use = 180 days or more]	Full rate of Dep
2. Purchase & put to use in different year [put to use = 180 days or more]	Full rate of dep in year of PTU
3. Purchase & put to used in same year [put to use = less than 180 days]	Rate of dep (x) 50% Allowed in year of PTU
4. Purchase & put to use in different year [put to use = less than 180 days]	Full rate of Dep

Important points

- Restriction allowed only when put to use & acquisition in same year and less than 180 days
- Day on which put to use not count.

Section 32(1)(ia)

Eligible scheme :- **Optional scheme only**
Eligible assessee :- **All assessee**
Eligible Asset :- **New plant & machine [except ship & aircraft]**

- New plant & machinery in any area
Rate of additional depreciation = 20%
- If put to use is less than 180 days
Rate of additional depreciation = 10% [balance 10% allowed in next year]
- Rate applicable on actual cost
- Purpose** = 1) Manufacturing or production of any article or things.
2) In the business of generation distribution & transmission.
3) The business of printing or printing & publishing amount to Manufacture.

Important points

- Not eligible** for additional depreciation
 - Any **second hand** plant & machine.
 - Plant & machinery installed in **office premises or residential accommodation.**
 - Office apartment or road transport vehicle.
 - 100%** of actual cost already allowed as **deduction u/s 35.**
 - Having business of **trading or providing services.**
- Additional Depreciation allowed only in **first year.**
- Allowed to assessee who exercise the **optional scheme.**
- Asset Put to use less than 180 days Depreciation allowed 10 % on actual cost , **balance 10 % Allowed** in immediately succeeding PY **only when assessee exercise optional scheme in succeeding PY.**
- Forklift truck can claim additional Depreciation.

Proviso to Section 32(1)

In the case of succession or amalgamation or demerger depreciation is allowed to predecessor and successor in the **ratio of no. of days for which assets were used by them in the PY when succession or amalgamation or demerger take place depreciation to be apportioned shall be computed assuming that amalgamation has not take place.**

Section 50 : Block of asset

picture abhi baki Hai mere dost !	picture khatam ho chuki Hai mere dost !
<p>BOA WDV on 1/4/24 = 35,00,000</p> <p>A1, A2, A3, A4, A5</p> <ul style="list-style-type: none"> Purchased on 20/6/24, PTO on same day = 15,00,000 Three asset sold from BOA 	<p>BOA WDV on 1/4/24 = 35,00,000</p> <p>A1, A2, A3, A4, A5</p> <ul style="list-style-type: none"> Purchased on 20/6/24, PTO on same day = 15,00,000 All asset sold from BOA
<p>Case 1 :- sale = ₹30,00,000</p> <p>WDV = 35,00,000</p> <p>(+) Purchase = 15,00,000</p> <p>50,00,000</p> <p>(-) Sale = (30,00,000)</p> <p>WDV = 20,00,000</p>	<p>Case 1 :- sale = ₹30,00,000</p> <p>WDV = 35,00,000</p> <p>(+) Purchase = 15,00,000</p> <p>50,00,000</p> <p>(-) Sale = (30,00,000)</p> <p>STCL = 20,00,000</p>
<p>Case 2 :- sale = ₹50,00,000</p> <p>WDV = 35,00,000</p> <p>(+) Purchase = 15,00,000</p> <p>50,00,000</p> <p>(-) Sale = (50,00,000)</p> <p>WDV = NIL</p>	<p>Case 2 :- sale = ₹50,00,000</p> <p>WDV = 35,00,000</p> <p>(+) Purchase = 15,00,000</p> <p>50,00,000</p> <p>(-) Sale = (50,00,000)</p> <p>WDV = NIL</p>
<p>Case 3 :- sale = ₹60,00,000</p> <p>WDV = 35,00,000</p> <p>(+) Purchase = 15,00,000</p> <p>50,00,000</p> <p>(-) Sale = (50,00,000)</p> <p>WDV = NIL</p> <p>Capital gain</p> <p>Sale price = 60,00,000</p> <p>Total cost. = 50,00,000</p> <p>STCG = 10,00,000</p>	<p>Case 3 :- sale = ₹60,00,000</p> <p>WDV = 35,00,000</p> <p>(+) Purchase = 15,00,000</p> <p>50,00,000</p> <p>(-) Sale = (60,00,000)</p> <p>STCG = 10,00,000</p>

Important points

- Agar picture baki Hai toh , yah toh WDV aayegi yah toh profit , **loss khabhi bhi nahi aayega.**
- Agar picture khatam ho gai he toh ,yah toh profit hoga ,yah toh loss hoga ,**WDV khabhi bhi nahi aayegi.**
- WDV can never be negative** it may zero or positive.
- Depreciation can **not be carry forward when WDV is NIL.**
- Notwithstanding anything contains in Capital gain chapter Depreciate asset is **always short term capital gain/loss.**

Section 32(2) : Carry forward and setoff of depreciation

Setoff of unabsorbed depreciation

- Current year depreciation can setoff against **any head except salary, casual income.**

Carry forward of unabsorbed depreciation

- Depreciation can be carry forward and Set-off against **any head except salary, casual income.**

Important points

- Unabsorbed depreciation can be carry forward **unlimited time.**
- In case of **Business is discontinue** carry forward of unabsorbed depreciation is allowed.
- ROI filed after due date or ROI not file**, setoff & carry forward of unabsorbed depreciation are allowed.
- Additional Depreciation cannot carry forward** if assessee opt default scheme.
- Priority of setoff :-**
 - Current year depreciation brought forward
 - B/F Business loss
 - Unabsorbed depreciation.

Section 43(6) : Computation of WDV

Particular	Amount
Opening WDV as on 1/4	xxx
Add :- Purchase new asset	xxx
WDV before depreciation	xxx
Less :- Depreciation of current year	(xxx)
WDV after depreciation/Closing WDV	xxx

Section 43(1) : Actual cost of asset

Actual cost of asset means

Particular	Amount
Cost of asset (Purchase price)	xxx
Add:- Installation charges	xxx
Add:- Transport expenses for asset	xxx
Add:- Trial run / Test expenses	xxx
Add:- Taxes & duties if ITC not available	xxx
Add:- Interest on loan taken for acquisition of asset upto the date of asset Put to use.	xxx
Less:- Amount record on sale of trial run product	(xxx)
Less:- Subsidy/Govt grants record for acquisition of assets	(xxx)
Actual cost	xxx

Where an assessee incurre any expenditure for acquisition of any asset or part thereof in respect of which payment or aggregate of payments made to a person in a day other than by an A/c payee cheque or A/c payee draft or use of electric clearing System exceed ₹10,000 ,such expenditure shall not part/form of actual cost such asset.

Chapter -5 PGBP

Section 32(1)(i) + 32(1)(ii) + 41(2) + 50A

Special provisions relating to power generating undertaking:-

Eligible assessee :- Electricity company

Option :- SLM or WDV

If opt WDV :-

Provision follow : 32(1)(ii) + 32(1)(ia) + 50

If opt SLM :-

Provision follow : 32(1)(i) + 32(1)(iii) + 41(2) + 50A

Provision

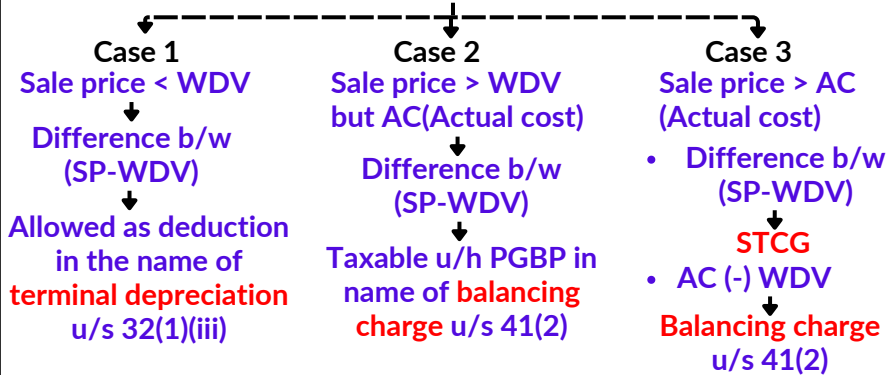

Section 43CA : Full value of consideration in case of land & building

Applicability = land or building or both as stock in trade

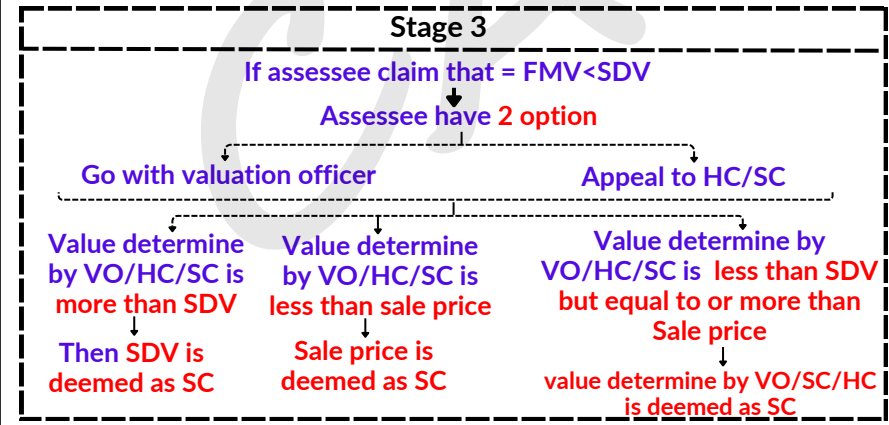
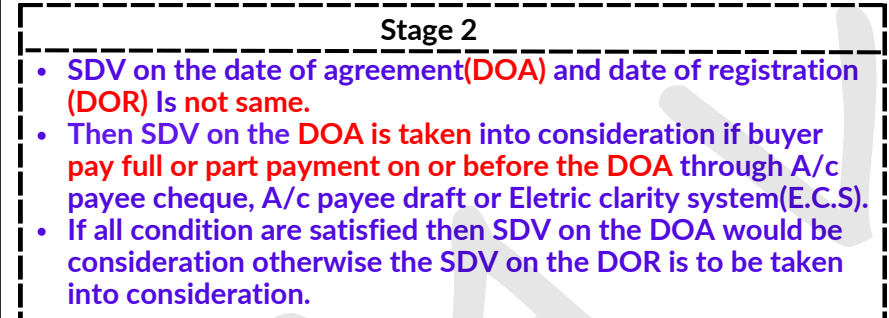
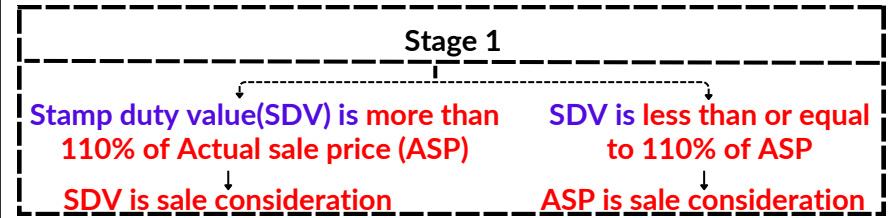

Section 10AA : Deduction if limit located in SEZ

Treatment:- Deduction after Gross total income

Condition:- SEZ start on or before 31/3/20

Unit located in SEZ :-

- Section 10AA is applicable
- 1st 5 years :- 100% profit arising from export sale is exempt.
- Next 5 years:-50 % profit arising from export sale is exempt.

Section 35 : Expenditure related to scientific research

Section	Assessee	Nature of expenditure	Deduction allowed
35(1)(i)	All	Revenue exp for scientific research • before Commencement 3 years before (raw material & salary) • After Commencement All revenue exp	100%
35(1)(ia)	All	Sum paid to specified company for scientific research	100%
35(1)(ii)	All	Donation to scientific institute.	100%
35(1)(iii)	All	Donation to scientific institute. (social science or statistical research)	100%
35(1)(iv)	All	Capital exp for scientific research • before Commencement 3 years before (raw material & salary) • After Commencement All exp except land • Dep not allowed because all cost allowed.	100%
35(2AA)	All	Sum Pais to IIT etc for scientific research.	100%
35(2AB)	only company	Expenditure on In-house research except negative good	100%
35(CCC)	All	Expenditure on agriculture extention	100%
35(CCD)	only company	Expenditure on skill development (on there Labour)	100%
35(DD)	only company	Expenditure related to amalgamation	Note 1
35(DDA)	All	Expenditure related to VRS (Voluntary retirement service)	Note 1

Note 1

- 100% Allowed in 5 equal installments.

Section 37(2B)

Expenditure on Advertisement in the magazine of political party are disallowed.

Section 35AD : Deduction for essential business

35AD is optional

S.NO	Business	% of deduction
1	Setting up & Operating a cold chain facility.	100%
2	setting up & Operating a warehousing facility for Agricultural produce.	100%
3	Laying & Operating cross country pipeline for distribution of petroleum, oil,natural gas.	100%
4	Building & Operating a hotel of 2 star & above.	100%
5	Building & Operating a hospital with min. 100 patient beds.	100%
6	Developing & building a housing project under affordable housing scheme.	100%
7	Production of fertilizer in India.	100%
8	Setting up & Operating Inland container depot or container freight station.	100%
9	Bee keeping and production of bee's honey & wax.	100%
10	Setting up & Operating warehousing facility of sugar.	100%
11	Laying & Operating a slurry pipeline for transportation of Iron ore.	100%
12	Setting up & Operating a semi conductor wafer fabrication manufacturer unit.	100%
13	Developing or manufacturing & Operating or	100%
14	Developing, maintain & Operating a new infrastructure facility.	100%

Important points

- Plant & machinery must be new ,exceptions-
→ Imported old plant & mach.(on which depreciation not claimed under IT act.
→ 20% of total plant & mach can be old.
- Deduction allowed on all capital expenses except land ,goodwill, financial instruments. Further,any expenditure In respect of which payment or aggregate of payment made to a person of an amount exceeding ₹10000 in a day otherwise than by A/c payee cheque, or A/c payee draft or use of ECS through a bank A/c would not be eligible for deduction.
- Depreciation not allowed if deduction claimed u/s 35AD.
- Loss of specified business can be carry forward indefinitely as per FA 2016, Assessee has to file ROI upto due date of ROI for c/f of Losses.
- If asset (on which deduction claimed u/s 35AD) is sold ,then entire sale price shall be taxable u/h PGBP.
- Loss of specified business can be setoff only against specified business income irrespective of whether the latter is eligible for deduction u/s 35AD.
- In case of Hotel (2 star or more) ,if assessee transfer operation to another person, than assessee shall be deemed to be carrying on specified business.
- Infrastructure facility Means:-
→ A road including toll road, a bridge, or A rail System.
→ A highway project including housing or other activities being an integral part of the highway project.
→ A port ,Airport ,Inland,waterway,inland port or navigation channel in the sea.
→ A water supply project ,water treatment System, Irrigation project ,sanitation & sewage System or solid waste management system.

Chapter -5 PGBP

Section 35AD : Continue

- Assets (on which deduction claimed u/s 35AD) should be exclusively used for business for **minimum 8 years from the year of acquisition.**
- If Asset used for **non- specified business within 8 year**, then following shall be taxable u/h PGBP -

Amount of deduction claimed u/s 35AD earlier	xxx
Less :- Depreciation that would have been Allowable if Sec 35AD not there	(xxx)
PGBP	xxx

Note :- Above point is not applicable if company becomes sick industrial company

- If asset is transferred from specified business to non specified business within 8 years then **Actual cost for non- specified business will be:-**

Cost of such asset	xxx
Less :- Depreciation Allowable if such asset used for non specified business from acquisition	(xxx)
Actual cost	xxx

Section 35ABB/ABA : Expenditure on Telecommunication license

Deduction allowed :- $\frac{\text{Total license cost}}{\text{No. of years}}$

What if license sold ?

Cost of license	xxx
Less :- amortise cost	(xxx)
Unamortise cost(UC)	xxx

Cases

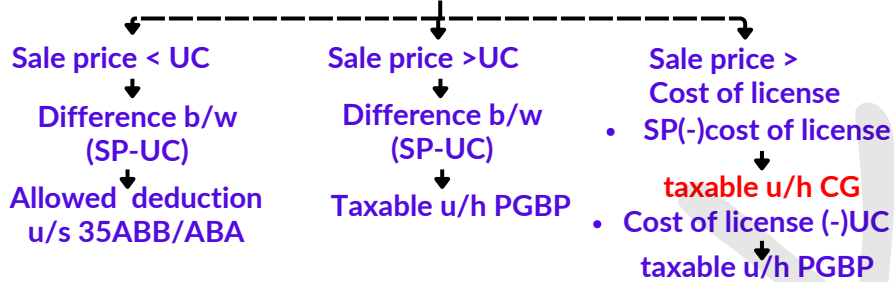

Section 36 + 40A(7) + 40A(9) : Specific deduction/ Certain deduction

- Premium paid on **SIT** of business or profession.
- Employer paid **Insurance premium** of Employee.
- Bonus** or commission.
- Interest** on capital borrowed. [Only for business not for asset of business]
- Discount on **zero coupon bond** on pro-rata basis.
- Employer contribution** in approved gratuity Fund, pension Fund, Provident Fund or any other Employee Welfare Fund.
- Bad debts** written off [Recovery of baddebts is taxable]
- STT** or **CTT** paid .
- Expenditure on **family planning** :- Revenue Expenditure **100%** allowed and capital expenditure allowed **1/5th** [Applicable only for company]
- Provision for baddebt** in case of specified bank.

Section 37 : General deduction

An expenditure shall be allowed under section 37 provided :-

- It is **not** in the nature of expenditure described u/s 30 to 36.
- It is **not** in the nature of **capital expenditure.**
- It is **not** a **personal expenditure** of the assessee.
- It is laid out & expended **wholly & exclusively for the purpose of business/profession.**
- It is **not** incurred for any purpose which is an offense or which is **prohibited by law**, and
- It is **not** an expenditure incurred by an assessee on **CSR activities** referred to in section 135 of companies act 2013

CRUX :- Revenue expenditure + 100% related to business + legal expenses + not a CSR expenses

Section 38(2) : Treatment of depreciation in case of capital asset used in both business & personal

If an asset like a building, machine, plant, or furniture is used for both business and personal purposes, Depreciation will be given **only for the business portion.** The taxpayer can't claim full benefits if the asset is not used entirely for business.

Amount not deducted/ Expenditure not allowed

Section :- 40(a)(i) + 40(a)(ia) + 40(a)(ii) + 40(a)(ib) + 40(a)(iii) + 40(a)(v) + 40A(2) + 40A(3) + 40A(3A)

Section 40(a)(i)

Applicable:- **In case of NR**

- 100% of payment not allowed** which is taxable in India made outside India or in India to NCNR or to foreign company on which either ;
→ **TDS has not been deducted**, or
→ After deduction has **not been paid** on or before due date of return u/s 139(1).
- If TDS has been deducted in subsequent year or has been deducted in PY but paid in subsequent year after due date of filling return u/s 139(1)
→ Such sum be **allowed** as deduction in computing income of **PY** in which such tax is paid.

Section 40(a)(ii)

- Any expenditure related to **Direct tax is disallowed.** (I.e income tax, cess, TDS, surcharge etc.)
- But expenditure related to **indirect tax is allowed u/h PGBP.** (I.e GST, VAT, custom duty).

Section 40(a)(iii)

Applicable:- **In case of salary made o/s india or to NR**

- on which **TDS has not been deducted** or after deduction not been paid before due date of filing return u/s 139(1)
100% disallowed.
- Even subsequent payment of TDS, deduction of salary not allowed.

Section 40(a)(ia)

Applicable:- **In case of Resident**

- 30% of payment not allowed** on which
→ **TDS has not been deducted**, or
→ After deduction has **not been paid** on or before due date of return u/s 139(1).
- If TDS has been deducted in subsequent year or has been deducted in PY but paid in subsequent year after due date of filling return u/s 139(1), **30% of Such sum** be **allowed** as deduction in computing income of **PY** in which such tax is paid.

Section 40A(3) + 40A(3A)

Revenue expenditure for which payment made to a person in a **single day**:-

- Upto ₹10,000 = Allowed in all cases [Irrespective of mode of payment]
- More than ₹10,000 = A/c payee cheque, A/c payee draft, ECS

Important points

- In case of **transporter limit is ₹35,000.**
- Exception of above provisions
→ Payment to RBI/SBI/Cooperative banks.
→ Payment made to govt.
→ Payment made to purchase Agricultural produce.

Section 43B

- Tax paid by Employer on perquisite value are disallowed.

Section 43B

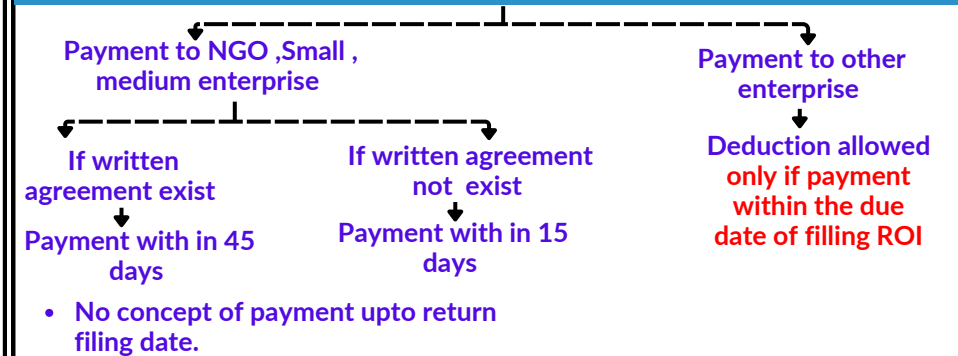

Section 33AB : Deduction in case of amount deposit in NABARD

Amount of deduction = a) Amount deposit
Or
b) 40% of income } **which ever is lower**

Section 35D

Expenditure Incurred before Commencement shall be allowed in 5 equal installments.

- Maximum limit :-
- Corporate assessee = 5% of cosy of project
Or
5% of capital employed
Whichever is less
 - non corporate assessee = 5% of cost of project.

Chapter -5 PGBP

Section 41(1) + 41(3) : Treatment of asset sold used for scientific research

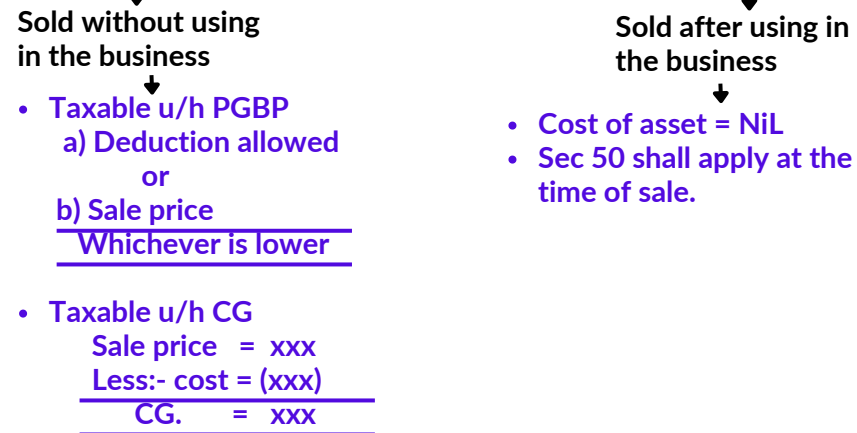

Section 40(b) : Deduction in case of any firm/LLP

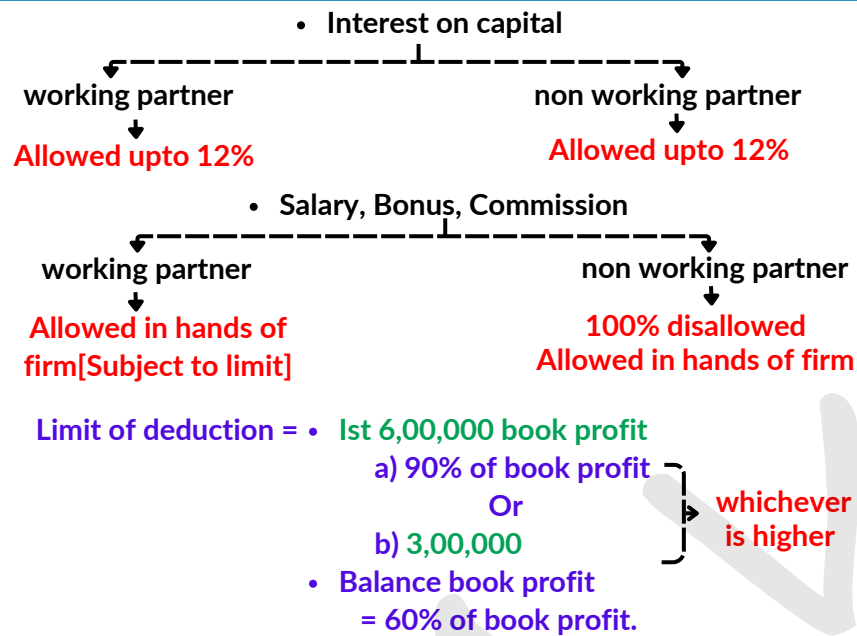

Important points

- Book profit means the net profit shown in P&L should be increased by remuneration paid or payable to all the partners and interest in excess of 12% which has been debited while computing net profit.
- Computation of book profit

Net profit as per profit & loss A/C	xxx
Add:- Remuneration paid or payable to all partners of firm.	xxx
Add:- Interest in excess of 12%	xxx
Book profit	xxx

Add only if same has been deducted while computing net profit

Section 44AA : Accounts & Records

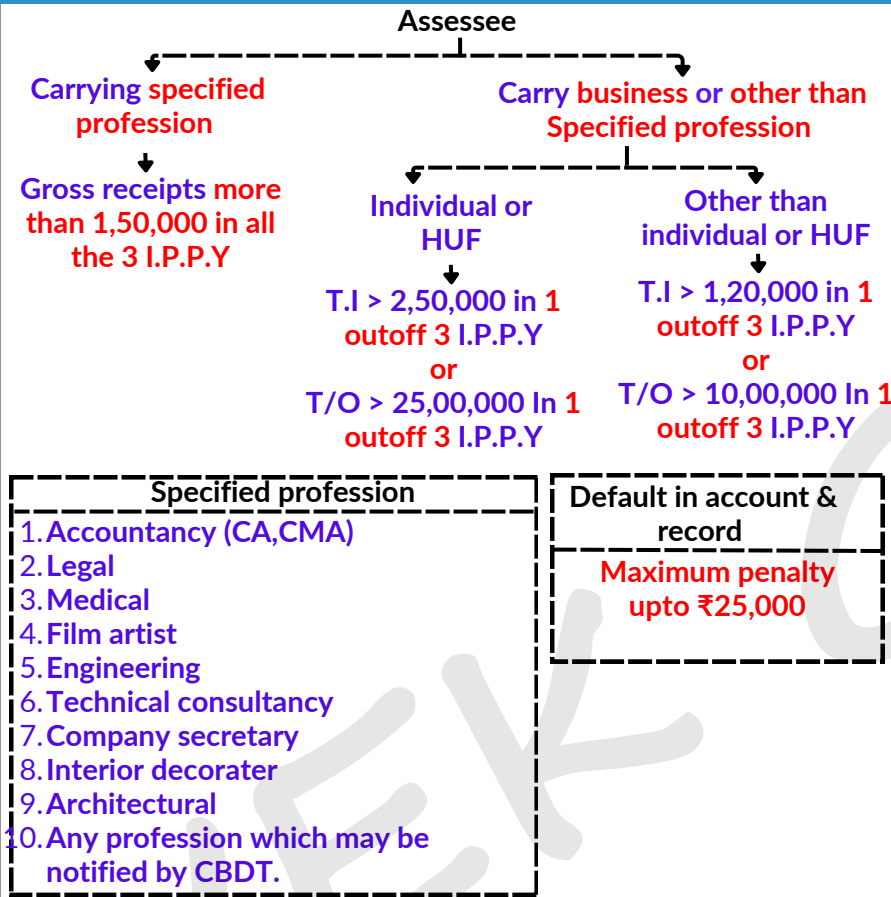

Section 44AB : Mandatory audit of accounts

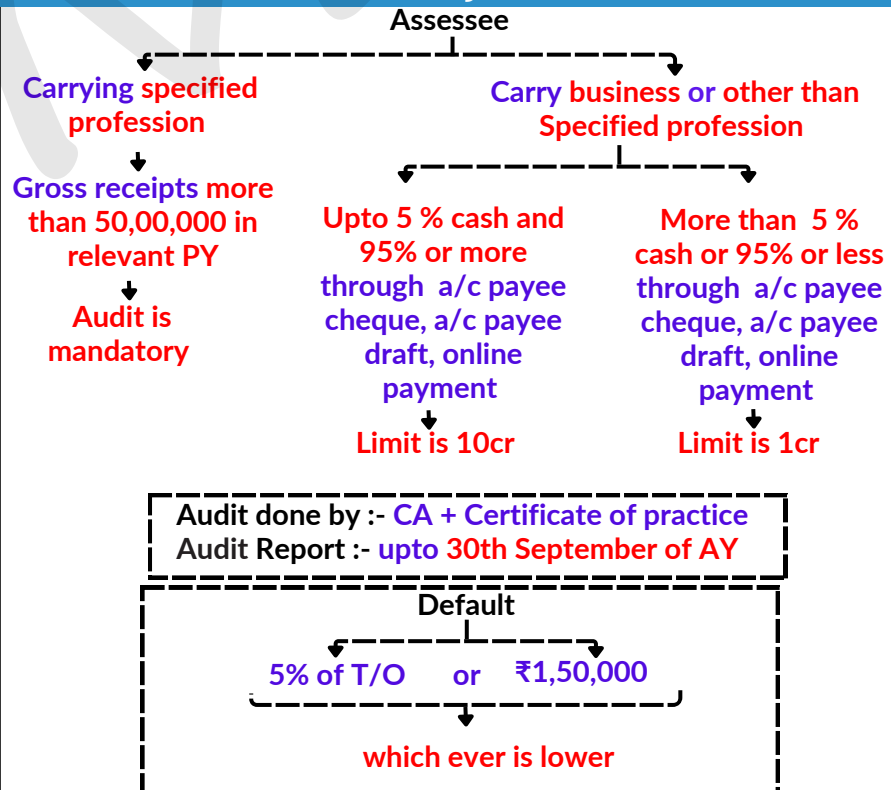

Section : 44AD/44ADA

	44AD	44ADA
Section name	Presumptive taxation for business or non specified profession	Presumptive taxation specified profession
Eligible assessee	Resident :- Individual, HUF, Firm (not include LLP)	Resident :- Individual, HUF, Firm (not include LLP)
Eligible T/O	Upto 5% cash and 95% or more online mode	Upto 5% cash and 95% or more online mode
	Satisfied	Satisfied
	T/O upto 3cr	GR upto 75 lakh
	Not Satisfied	Not Satisfied
	T/O upto 2cr	GR upto 50 lakh
Deemed PGBP Income	<ul style="list-style-type: none"> 8% of T/O 6% of T/O [If payment received through special mode upto due date of ROI] 	50% of T/O
Expenditure allowed or disallow	<ul style="list-style-type: none"> No allowed No disallowed 	<ul style="list-style-type: none"> No allowed No disallowed
Books of A/c	Not Required	Not Required
Setoff of loss	Yes allowed	Yes allowed
Deduction u/s VI-A	Yes allowed	Yes allowed
lock in period	5 Year [If you want to take 44AD then you have to take it for 5 year continuously. if you withdraw in between then it cannot taken back]	No lockin

Section 44AE

Applicable:- Any assessee who owns not more than 10 hoods carriage during the PY.

- Heavy good vehicle:- 1000 per ton ,per vehicle, per month or part of month.
- Other than heavy goods vehicle:- 7500 per vehicle, per month or part of month.

Important points

- Heavy goods vehicle = Gross weight more than 12000kg.
- Use Kitna Kiya voh matter nahi karta ,hold Kitna Kiya he yeh matter karta he !

Example

no. Of vehicle	Gross weight (kg)	HOLD	Goods vehicle	Calculation	Deemed income
2	11000(1)	4m 10days	N.G.V	7500×2×5	75000
1	12400	6m 5 days	N.G.V	7500×1×7	52500
3	18000(1)	8m	H.G.V	1000×18×3×8	432000
1	13600	9m	H.G.V	1000×1×14×9	126000
2	15000(1)	4m 20 days	H.G.V	1000×15×2×5	150000

Chapter - 6 Capital Gains

Section 45(1) : Charging section of Capital gain

Any income **Arise from** Transfer **of** Capital asset

If **All above condition are satisfied** then such income shall be chargeable to tax under head " Capital gain "

Capital gain **taxable in the year of transfer**, consideration when receive doesn't matter.

Important points

- Income **includes Losses also**.
- Taxable on **accrual basis** (I.e due basis).
- Capital gain is exempt u/s 54,54B,54D,54E,54EA,54F,54G, 54EB, 54H.

Section 2(14) : Capital asset

Capital asset means

Clause-a

Property of any kind held by an assessee **whether or not** connected with his business or profession is a capital asset.

But does not include

- Stock in trade (other than clause b).
- Personal effect movable property [including wearing apparel and furniture] **held for personal use** by assessee or dependent family member **but excludes**-
 - Jewellery [other than silver utensils]
 - Archaeological collections
 - Drawings
 - Paintings
 - sculptures, or
 - Any work of art
- Agricultural land in India not a capital asset except:-**
 - Agricultural land in the municipality-

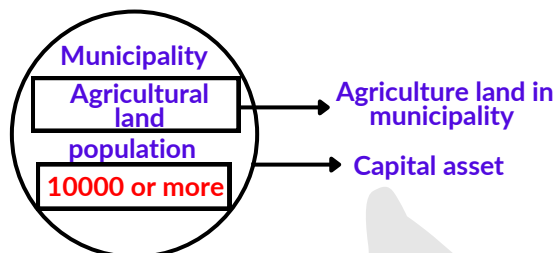

ii) Agricultural land outside the municipality

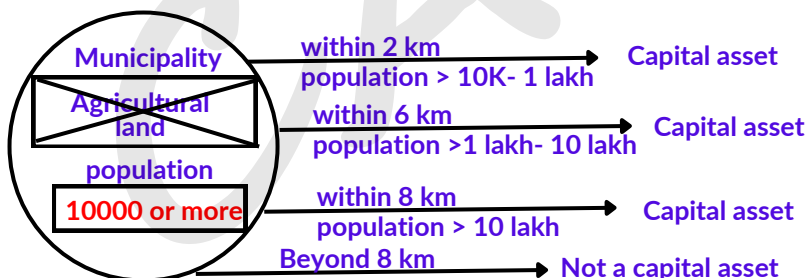

Note :- Agricultural land in foreign country is always a capital asset.

- Gold deposit bonds (GDB) issued under GDB ,1999 or deposit certificate gold monetization scheme 2015.[Int exempt u/s 10(15)]

Section 2(14) : Continue

Clause-b

Any securities held **by FII** always treated as capital assets.

Clause-c

Unit linked Insurance policy (ULIP)
[Section 45(1B)]

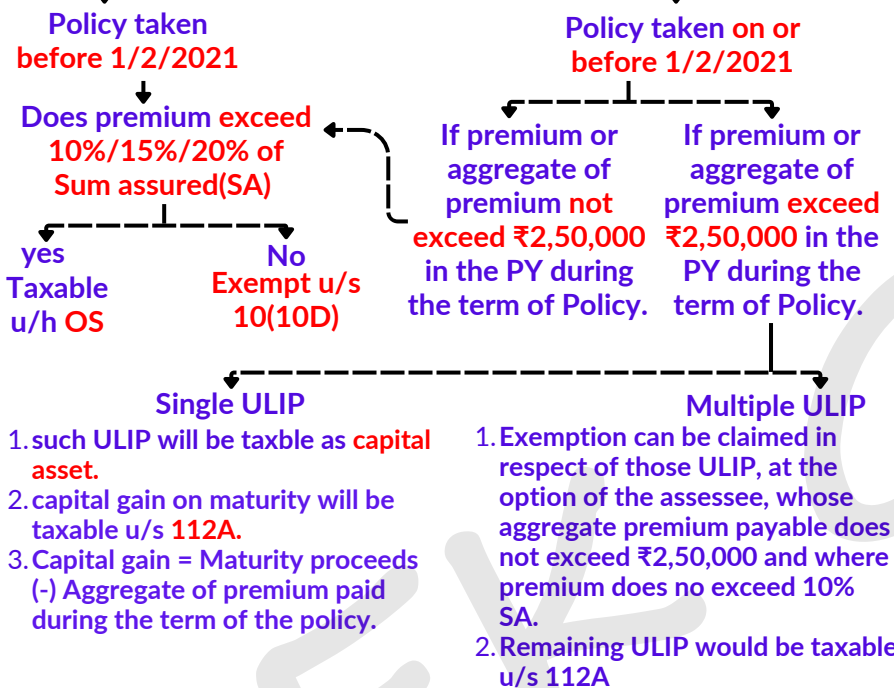

Section 2(47) : Transfer

Transfers includes

- Sale
- Exchange
- Relinquishment
- Exlinquishment
- Compulsory acquisition under any law
- Possession of immovable property
- Allotment of property by cooperative society to member
- Redemption to zero coupon bond
- Conversation of capital asset in stock in trade.

Section 48 : Computation of capital gain

STCA		LTCA	
Sale price	xxx	Sale price	xxx
Less:- Expenses on transfer(EOT)	(xxx)	Less:- Expenses on transfer(EOT)	(xxx)
Net sale price	xxx	Net sale price	xxx
Less:- Cost of acquisition(COA)	(xxx)	Less:- Index cost of acquisition(ICOA)	(xxx)
Less:- Cost of improvement(COI)	(xxx)	Less:- Index cost of improvement(ICOI)	(xxx)
Short term capital gain(STCG)	xxx	Long term capital gain(LTCG)	xxx

Note:-1 Indexation benefit not allowed if asset transfer on or after 23/7/2024.

Section 2(42A) : Short term capital asset/ period of holding of asset

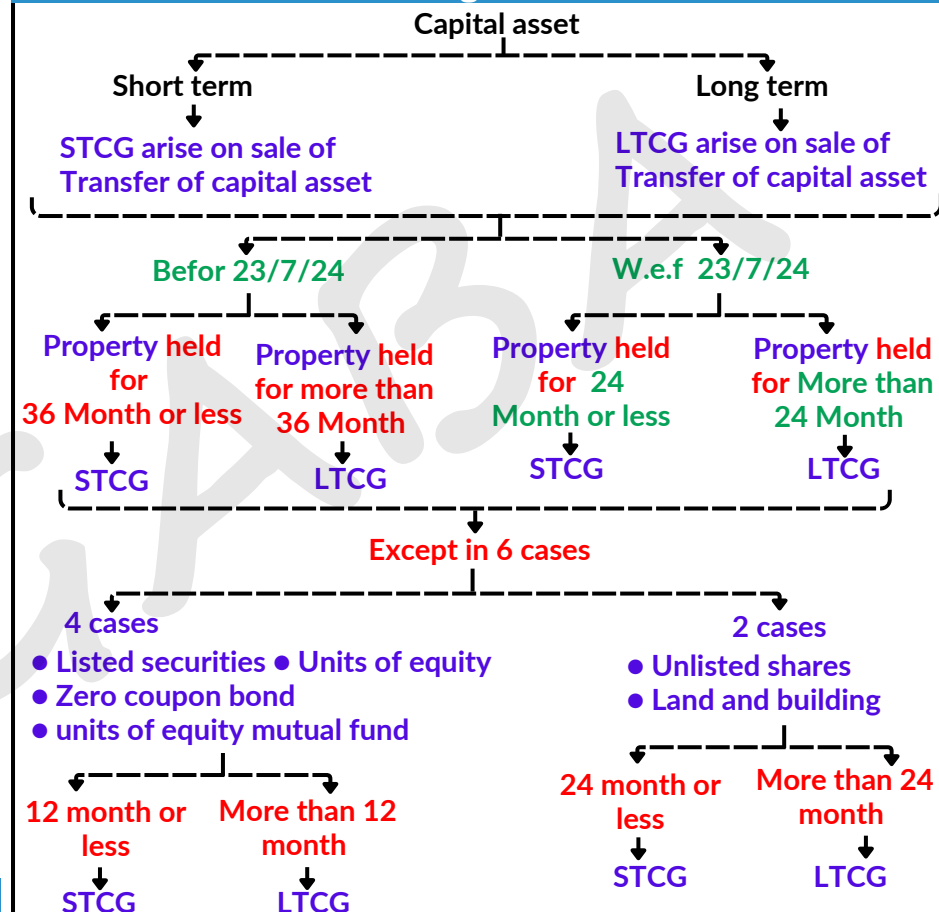

Note:-1 • Period of holding Start from **date of acquisition**.
• End to immediately preceding the **date of Transfer**.

Section 50AA

Notwithstanding anything contained in sec 2(42A) following capital asset shall be treated **always Short term capital asset** [irrespective of the holding period]

- Depreciable asset u/s 50
- Units of specified mutual fund acquire on or after 1/4/2023.
- Market link debenture.
- Unlisted bonds or Unlisted debenture which is transferred or redeemed on or after 23/7/24.

Section 55 : Cost of acquisition/Cost of improvement

Part A :- Cost of acquisition

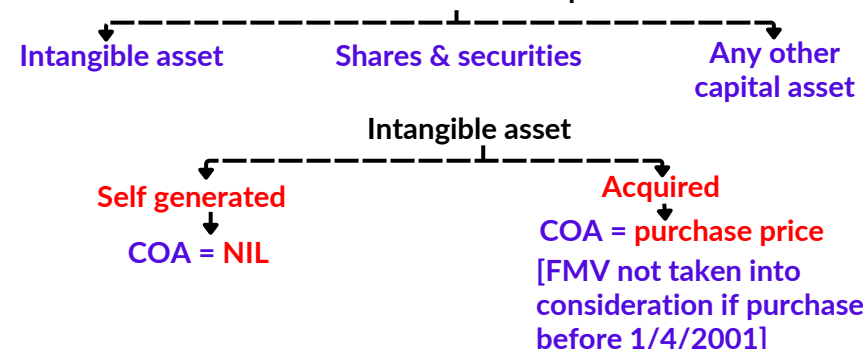

Chapter - 6 Capital Gain

Section 55 : Continue

Shares & securities

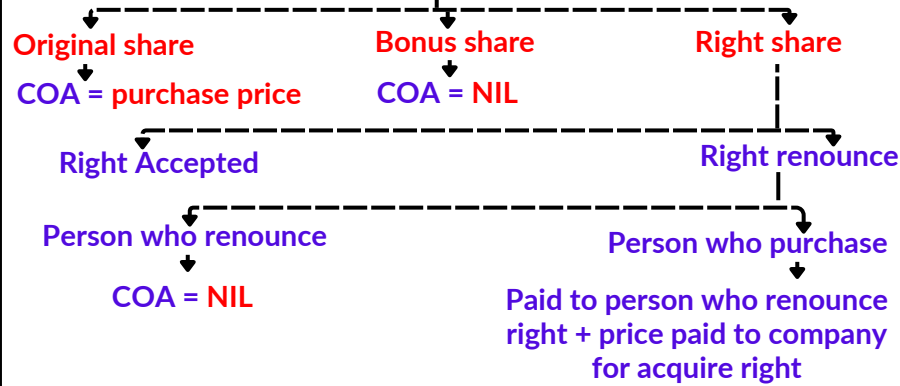

Note :- Option to take FMV is Available on share[All three type] acquire before 1/4/2001. COA = Purchase price or FMV on 1/4/01

Higher

Any other capital asset

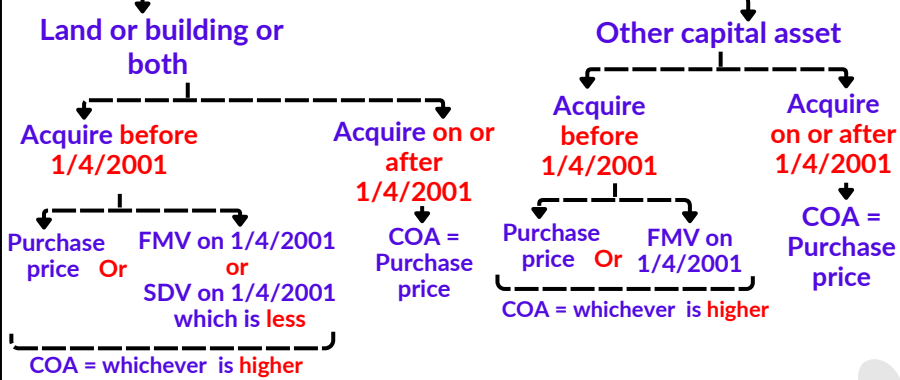

COA. → ICOA	COI → ICOI
Acquire before 1/4/2001 $\frac{COA}{100} \times \text{Index rate of years of Transfer}$	Improvement before 1/4/2001 Ignore in all cases
Acquire on or after 1/4/2001 $\frac{COA}{\text{Index rate of years of Acquisition}} \times \text{Index rate of years of Transfer}$	Improve on or after 1/4/2001 $\frac{\text{Actual expenditure}}{\text{Index rate of years of Improvement}} \times \text{Index rate of years of Transfer}$

Note:-1 Indexation benefit not allowed if asset transfer on or after 23/7/2024.

Section 50C : Full value of consideration in case of land & building

Applicability = land or building or both as stock in trade

Stage 1

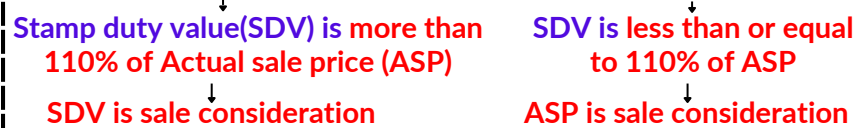

Section 50C : Continue

Stage 2

- SDV on the date of agreement (DOA) and date of registration (DOR) is not same.
- Then SDV on the DOA is taken into consideration if buyer pay full or part payment on or before the DOA through A/c payee cheque, A/c payee draft or Electric clarity system (E.C.S).
- If all condition are satisfied then SDV on the DOA would be consideration otherwise the SDV on the DOR is to be taken into consideration.

Stage 3

If assessee claim that = FMV < SDV

Assessee have 2 option

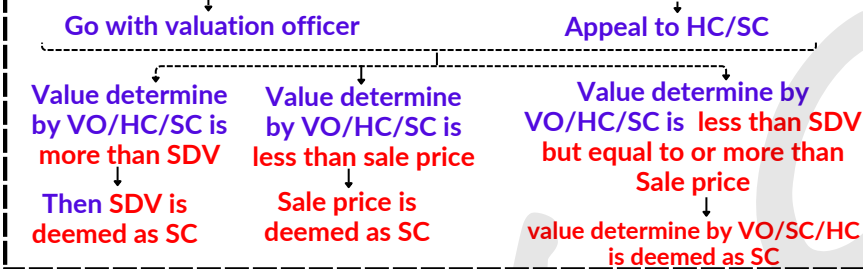

Section 50D

Where sale price is not ascertainable or determined, FMV on transfer of Capital asset deemed to sale consideration.

Section 50CA

Applicability = Only on Unlisted shares

Sale price < FMV

FMV deemed sale consideration

Section 47 : Certain transaction not regarding as transfer

- Asset transfer on the partition of HUF.
- Gift, Will.
- Amalgamating co. transfer asset to Amalgamated co. [Indian co.]
- Holding co. [100% holding] transfer asset to subsidiary co. [Ind co.]
- Subsidiary co. Transfer asset to holding co. [holding 100% + Indian co.].
- Transfer or capital asset by the de-merger company to the resulting Indian company in case of de merger.
- Transfer of shares by a shareholder in a scheme of amalgamation or de-merger.
- Transfer on conversion of bonds or Debentures into shares.
- Conversion of preference shares to equity shares.
- Transfer of capital asset under reverse mortgage.
- Conversion of gold into electronic gold receipt or vice versa.
- Redemption of sovereign gold bonds by an individual.
- Transfer of Govt securities O/S India by a Non resident to another non resident

Section 45(1A) : T/F on Insurance claim received

Year of Transfer	Year of Destruction/ destroy
Year of Taxable	When Insurance claim received
Year of Indexation	Year of Transfer [i.e Destruction]
Holding period	Immediately the date of Transfer [i.e Destruction]
Sale price	Insurance claim or FMV of asset

Section 45(2) : Conversation of Capital asset into SIT

Year of Transfer	Year of conversion
Year of Taxable	when SIT Sold
Year of Indexation	Year of Transfer [i.e Conversion]
Holding period	Immediately the date of Transfer [i.e Conversion]
Sale price	FMV on the date of Conversion

Section 45(5) : Compulsory acquisition

Year of Transfer	Year of Compulsory acquisition
Year of Taxable	a) Original compensation In the PY in which 1st installment received. b) Enhanced compensation → Enhanced by interim order • Taxable the year in which final order is come. → Enhanced by final order • Taxable in the PY in which compensation received by the assessee.
Year of Indexation	Year of Transfer [i.e Compulsory acquisition]
Holding period	Immediately the date of Transfer [i.e CA]
Sale price	Compensation received

Note :- COA only less from original compensation.

Section 45(5A) : Joint Development

Year of Transfer	Possession of Immovable property
Year of Taxable	Construction completion certificate issue
Year of Indexation	Year of Transfer [i.e possession]
Holding period	Immediately the date of Transfer [i.e possession]
Sale price	Cash (if any) + SDV of constructed area

Chapter - 6 Capital Gains

Section 51 : Advance money forfeited

Advance money

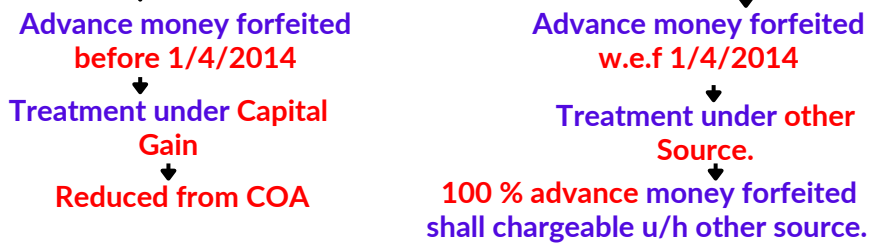

Note :-

- First forfeited amount less from COA after Indexation available.
- COA can be Zero but can't be negative.

Section 50B : Slump sale

Transfer 1 or more undertaking, value of asset & liability not assigned payment in lump sum if determining then only for stamp duty.

- Slump sale affected capital gain taxability.
- Holding undertaking more than 36 months = LTCG.
- Nothing shall be taxable u/h PGBP.
- COA or COI = net worth [Total asset - Total liability]
- While computing net worth:-
 - ➔ Revaluation of asset not considered.
 - ➔ Non depreciable asset taken on book value.
 - ➔ Depreciable asset taken on WDV.
- Indexation not allowed.
- Sale consideration= Higher of FMV1 or FMV2 .
- FMV1 = FMV of undertaking T/F
- FMV2 = FMV of asset of undertaking T/F

Section 46 : Capital gain on distribution of asset of company on liquidation

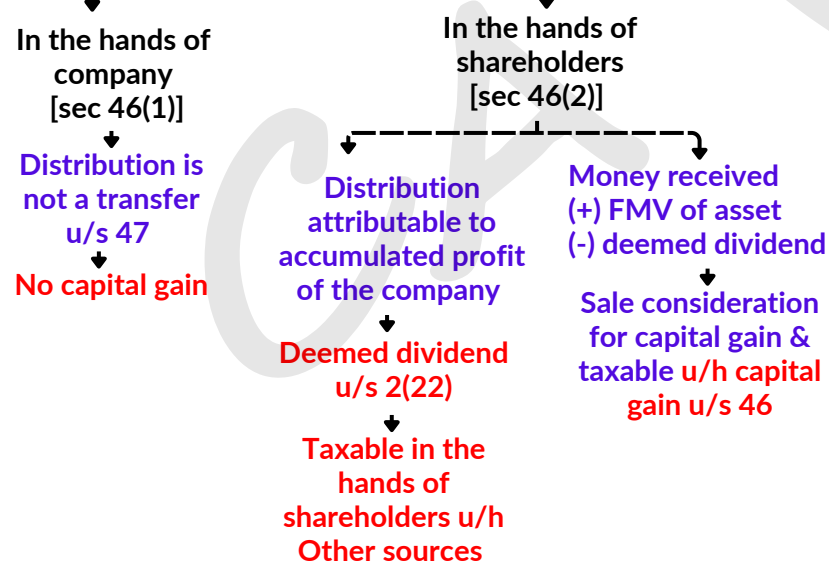

Section 112A : Tax on LTCG certain case

LTCG on :-

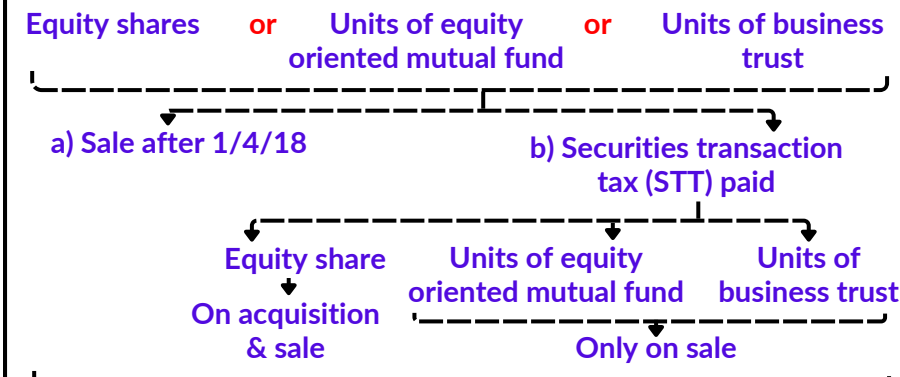

If both a & b condition

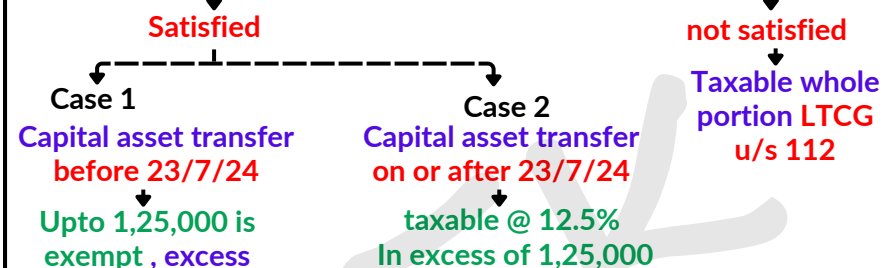

How to compute capital gain

Sale consideration	xxx
Less : Expenses on transfer	(xxx)
Net sale consideration	xxx
Less : Cost of Acquisition	(xxx)
LTCG 112A	xxx

Cost of acquisition

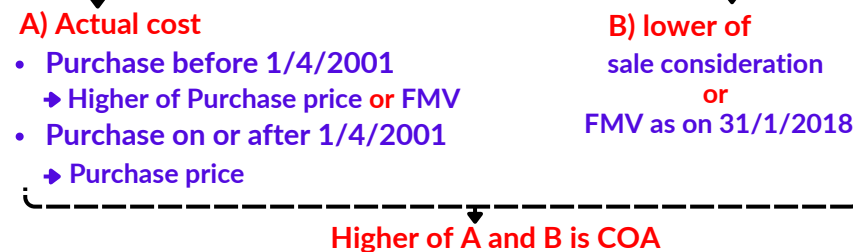

Important points

- Indexation not allowed.
- manner of use exemption of 1,25,000 not prescribed [preferable 12.5%].
- Limit of 1,25,000 aggregate for year.
- Deduction u/s VI-A not allowed.
- No rebate u/s 87A allowed.
- In case of resident individual/HUF benefit of balance exemption limit is available.

Tax rates in case of LTCG u/s 112

- Capital gain not cover under LTCG 112A are taxable under LTCG 112

Case 1 :- Acquire before 23/7/24 and Transfer before 23/7/24

Sale price	xxx
Less:- Expenses on transfer(EOT)	(xxx)
Net sale price	xxx
Less:- Index cost of acquisition(ICOA)	(xxx)
Less:- Index cost of improvement(ICOI)	(xxx)
Long term capital gain(LTCG)	xxx

20 % flat rate u/s 112

Case 2 :- Acquire before 23/7/24 and Transfer after 23/7/24

Sale price	xxx
Less:- Expenses on transfer(EOT)	(xxx)
Net sale price	xxx
Less:- Cost of acquisition(COA)	(xxx)
Less:- Cost of improvement(COI)	(xxx)
Long term capital gain(LTCG)	xxx

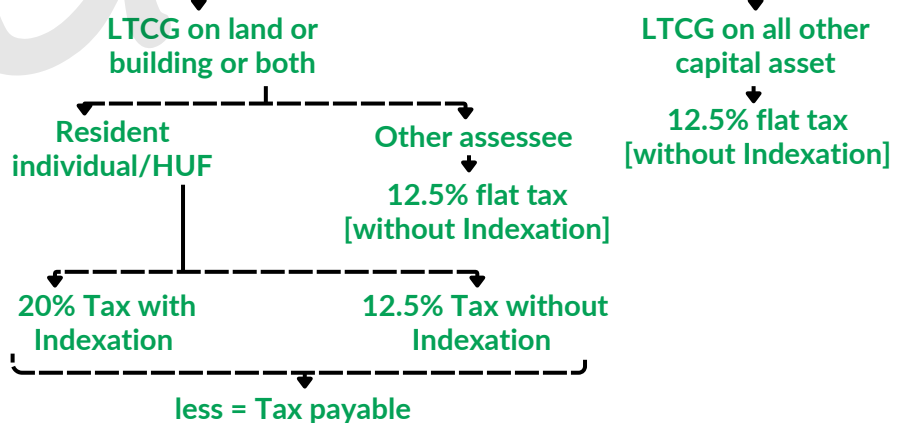

- In case of resident individual/HUF if immovable property transfer on or after 23/7/24 and such property acquired before 23/7/24 then tax on such LTCG112 will be lower of 12.5%(without Indexation) or 20% (with Indexation).
- Above option is applicable for only calculation of tax not for calculation of Capital gain and total income.

Case 3 :- Acquire after 23/7/24 and Transfer after 23/7/24

Sale price	xxx
Less:- Expenses on transfer(EOT)	(xxx)
Net sale price	xxx
Less:- Cost of acquisition(COA)	(xxx)
Less:- Cost of improvement(COI)	(xxx)
Long term capital gain(LTCG)	xxx

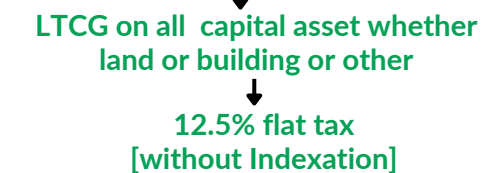

Chapter - 6 Capital Gains

Tax rates in case of STCG

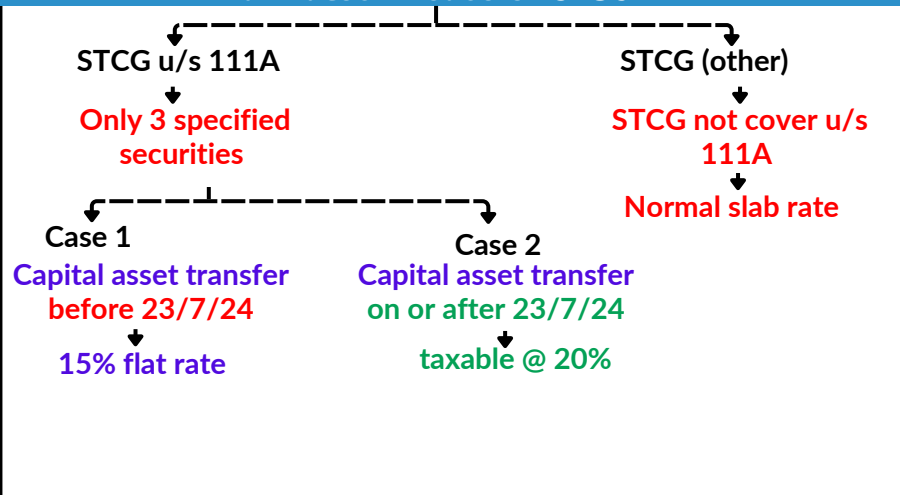

Section 46A : buyback of shares + deemed dividend

- The sum paid by a domestic company for purchase of its own shares shall be treated as dividend in the hands of shareholders who received payment from such buyback of shares shall be charged to income tax at applicable.
- No deduction for expenses shall be available against such dividend income while determining the income from other source. The Cost of acquisition of the shares which have been brought back would generate a capital loss in the hands of the shareholders.

(1)	(2)		(3)	(4)
Taxability in hands of	Buyback of shares by domestic companies		Buyback of shares by a company, other than a domestic company	Buyback of specified securities by any company
	Buy back effected before 1/10/2024	Buy back effected on or after 1/10/2024		
Company	Subject to additional income @23.296%	Not subject to tax in hands of the company	Not subject to tax in hands of the company	Not subject to tax in hands of the company
Share holders/ holder of specified securities	Income arising to shareholder exempt under 10(34A)	Income arising to shareholder would be treated as dividend and no deduction would be available against such dividend consequently, value of consideration received by shareholder on buyback would be NIL.	Income arising to shareholder taxable as capital gain u/s 46A	Income arising to holder of specified securities taxable as capital gain u/s 46A

SOME MISCELLANEOUS POINTS

- Indexation benefit not available in case of any bond or Debentures. Except Capital index bond or sovereign bond [it means Indexation available if transfer before 23/7/24].
- STT paid on sale or purchase not allowed as deduction.

Exemption of capital gain [sections 54 to 54F]

S.NO	Particulars	Section 54	Section 54B	Section 54D	Section 54EC	Section 54F
1	Eligible assessee	Individual /HUF	Individual /HUF	Any assessee	Any assessee	Individual /HUF
2	Asset Transferred	Residential house (LTCG)	urban Agricultural land	Land & building forming part of an industrial undertaking	Land or building or both	Any LTCG other than Residential house
3	Qualifying asset i.e asset in which capital Gains has to be invested	one residential house situated in India or two residential house in India at the option of the assessee where capital gain does not exceed ₹ 2 crore	Land for being used for Agricultural purpose (urban/rural)	Land or building or right in land or building	Bond of NHAI or RECL or any other bond notified by CG (redeemable after 5 years)	One residential house situated in India
4	Time limit for purchase/ construction	<ul style="list-style-type: none"> Purchase within 1 year before or 2 year after the date of Transfer or Construct within 3 year after the date of Transfer 	Purchase within 2 year after the date of transfer	Purchase/ contract within 3 years after the date of Transfer, for shifting or re-establishing undertaking or setting up a new undertaking	Purchase within 6 months after the date of Transfer	<ul style="list-style-type: none"> Purchase within 1 year before or 2 year after the date of Transfer or Construct within 3 year after the date of Transfer
5	Amount of exemption	<ul style="list-style-type: none"> Capital gain upto 2 crore Two residential house or Capital gain, which ever is lower Capital gain more than 2 crore or upto 10 crore one residential house or Capital gain, whichever is lower. Capital gain more than 10 crore No exemption available . 	Cost of new Agricultural land or capital gain ,which ever is lower.	Cost of new asset or Capital gain ,whichever is lower	Capital gain or 50 Lakh whichever is lower	<ul style="list-style-type: none"> Amount invest more than or equal to net sale consideration. Entire capital gain exempt. Amount invest less than capital gain. $\frac{\text{capital gian}}{\text{Net sale consideration}} \times \text{Amount invest}$ If cost of new residential house exceeds 10 crore ,the amount exceeding 10 crore would not be taken into account for exemption.

Chapter -7 Income from Other sources

Section 56(1) : Charging section

If Any income not chargeable to tax under any 4 heads of Income than such income shall be chargeable to tax u/h "other sources" This is called residuary head of income

Section 56(1) : Charging section

1. Dividend income [Note 1]
2. Casual income [Note 2]
3. Consideration received compensation received due to termination of any contract or modification as of any contract.
4. Advance money forfeited w.e.f 1/4/2014.
5. Interest on compensation [Note 3]
6. Family Pension received [Note 4]
7. Guest lecture salary.
8. Interest on securities.
9. Income for from letting out on hire of machinery plant or furniture.
10. Income arise form vacant land (if not taxable u/h PGBP)
11. Composite rent :- inseparable
12. Gift [Note 5]
13. Sum received including the amount allocated by way of bonus ,under a life insurance plan other than ULIP and keyman Insurance policy, which is not exempt u/s 10(10D)
14. Any other income which is not chargeable to tax

Note 1 : casual income

Section 115BB

Income from lottery crossword, puzzles, horse race ,gambling, betting etc.

- Tax rate = 30% flat
- no expenditure can allowed from such income
- Deduction u/s VI-A shall not allowed.
- Balance exemption limit can't be use.

Section 115BBJ

winning from online games

- Tax rate = 30% flat
- no expenditure can allowed from such income
- Deduction u/s VI-A shall not allowed.
- Balance exemption limit can't be use.

Note 2 : Family Pension received

Family Pension taxable

Opt optional scheme

Opt default scheme

Family Pension received less :- Deduction 1/3rd of Family Pension Or ₹15,000 p.a Whichever is less	xxx (xxx)	Family Pension received less :- Deduction 1/3rd of Family Pension Or ₹25,000 P.a whichever is less	xxx (xxx)
Taxable	xxx	Taxable	xxx

Note 3 Taxation of gift [section 56(2)(x)]

Applicability:- Gift received by any person [i.e recipient]

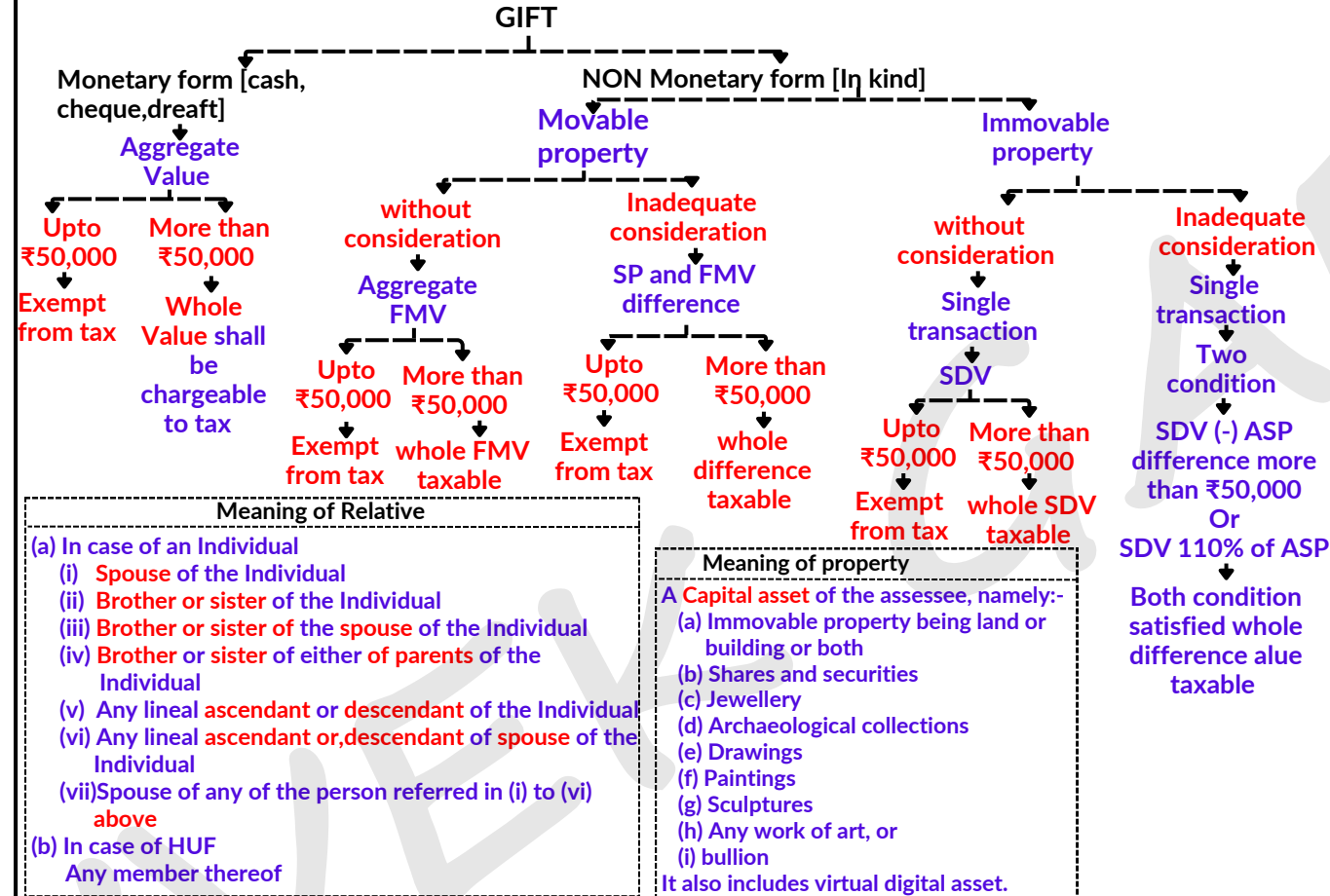

Family of individual
Family in relation to an individual means:-

- The spouse and children of the individual and
- The parent, brother and sister of the individual or any of them wholly or mainly depend on the individual.

Non applicability of section 56(2)(x)
Money or property received in the following cases is not taxable under Section 56(2)(x):

1. From specified persons or events:
 - Relatives
 - On marriage
 - Under a will or inheritance
 - In contemplation of death
2. From specific entities:
 - Local authorities
 - Registered trusts, educational institutions, hospitals, or medical institutions
3. Exempt transactions:
 - Certain transactions under Section 47
4. COVID-19-related exemptions:
 - Medical treatment expenses for self or family, subject to documentation
 - Financial aid to family of deceased (due to COVID-19):
 - From employer: No limit
 - From others: Up to ₹10 lakh
 - Death must occur within 6 months of diagnosis
 - Required records must be maintained and reported within 9 months

Note 4 Dividend income

Computation of taxable dividend

Dividend received.	xxx
less :- Deduction	
a) Interest paid.	(xxx)
b) Other exp[not allowed]	
taxable	xxx
Interest calculation	
a) actual interest	
or	
b) Total Dividend × 20%	
which is less	

Type	Description	Taxability
(a) Distribution of asset	Accumulated profits distributed as cash or asset.	Market value taxed as deemed dividend
(b) Debentures & Bonus shares	Issuance of Debentures, deposit certificate, or bonus shares to PSH	Market value taxed as deemed dividend
(c) liquidation distribution	Distribution of profits before liquidation	Considered dividend
(d) Capital reduction	Distribution of profits during capital reduction	Considered dividend
(e) Loan/Advance to shareholder	Loan/Advance to shareholder (above clarification)	Taxed as deemed dividend

Clarification on loan & advance to shareholder

Section 2(22)(e) states that any loan or advance given by a closely held company (i.e., a company in which the public is not substantially interested) to

- A shareholder holding 10% or more of voting power, or
- A concern in which such a shareholder holds at least 20% beneficial interest

will be treated as deemed dividend, to the extent of the company's accumulated profits.

Note 5 Interest on compensation

Interest on compensation (Whether original or enchanced)	xxx
Less:- Deduction @ 50% of interest received	(xxx)
Taxable	xxx

Following income is exempt

1. Income by way of interest on money standing to his credit in a non resident express account is exempt.
2. The value of scholarship granted to meet the cost of education would be exempt.
3. Daily allowance and consents allowance receive by MP or state legislature is exempt.
4. Interest on post office saving bank account is exempt up to the following specific limit
3500 of an individual account or 7000 in case of joint account
5. Gold deposit Bond(interest) deposit certificate is exempt

Chapter -8 Clubbing of income

Section 60 : Transfer of income without Transfer of asset

- If any person **transfer the income** whether revocable or not from any asset
- **without transferring** the Asset itself
- Such income is to be **included** in the total income of **transferor**

Section 61 : revocable transfer of assets

- All income arising to any person by virtue of **revocable transfer** of asset
- Shall be chargeable to income tax as the income of the transferor and
- Is to be **included** in the total income of **transferor**

Section 63 : revocable transfer

1. It contains any provision for **retransfer directly or indirectly** of the whole or any part of the income or assets to the **transferor, or**
2. It gives in any way to the transferor **right to assume power directly or indirectly** over the whole or any part of income of the assets

Section 62 : Exceptions where Clubbing provisions are not attracted even in case of revocable transfer i.e. irrevocable transfer

Transfer not revocable during the **lifetime** of the beneficiary on the transferee

- If there is a transfer of asset which is **not revocable**
- During the **lifetime** of the transferee
- The income from the transferred asset is **not includable** in the total income of the **transferor**
- **Provided** the transferor **not derives any direct or indirect benefit** from such income

Exception

- If the transferor received **direct or indirect benefit from such income**, such income is to be included in his total income of transferor even through the transfer may not be revocable during the lifetime of the transferee
- Income shall be clubbed in the income of the transferor, as and **when power to Revoke arise** i.e. on the date of the beneficiary/transferee.
- Actual revocation of asset is **not relevant**.

Section 64(1)(iii) : Remuneration of spouse

If spouse of an individual is **receiving salary, commission, fees** or any other form of remuneration, whether in cash or in kind from a concern in which such **individual as a substantial interest** shall be **included** in income of **individual**

Focus area

- where spouse possesses **technical or professional qualifications** and the income to the spouse is solely attributable to the application of his/her technical all professional knowledge or experience the income **shall not be Clubbed**.
- **Substantial interest** : A person is said to have substantial interest in concern if he is **owner of at least 20%** of the concern, Ownership of his **relative shall be also be included**.
- Technical of professional qualification shall include not only degree or membership but also **experience or natural talent**.
- Where **both** husband and wife have **substantial interest** in a concern and both are in receipt of **income by way of salary** etc from the said concern such income will be includable in hands of that spouse whose total income excluding such **income is higher**.
- where such income is once included in the total income of either spouse, any such income arising in any **subsequent year will not be included** in the total income of the **others spouse unless the assessing officer is satisfied** after giving the spouse an opportunity of being heard that it is necessary to do so.

Section 64(1)(iv) : Income from asset Transferred to spouse

When any assets is gifted by an individual to his/her spouse any income from such assets shall be **deemed to be income of transferor**(this section apply to all assets **except house property**)

Exception

1. If **relationship** of husband & wife **doesn't exist** at the time of transfer or accrual of income.
2. Transfer is under an agreement to **live apart**

Section 64(1)(vi) : Income from asset Transferred to wife without inadequate consideration by father in law mother in law

Asset transferred to a person or an **AOP(trust)** without **inadequate consideration** for immediate or deferred benefit of his/her spouse or son's wife. Income from such asset to be **clubbed** in the hands of the **transferor**.

Section 64(1A) : Income of minor child

1. All income of a minor is to be **included in the income of his parent** whose **total income is greater** before clubbing the income of minor child.
2. If **marriage** of the parents **does not subsist** the income of the minor will be **includable** in the income of that parents who **maintains the minor child**.
3. Where such income is once included in the total income of either parent, any such income arising in any **subsequent year will not be included** in the total income of the **other parents unless the AO is satisfied** after giving that parent an opportunity of being heard that it is necessary to do so.
4. If **none of the parents is alive** minor child file return through legal **guardian**. there shall be no clubbing even if grand parents or alive or not.
5. If the minor child become major during the PY then the incomes which have accrued to him **till the date he attains majority shall be clubbed**.
6. In the following cases income of minor child shall not be included:-
 - a) Child **suffering from any disability** of the nature specified in the section 80U shall not be included in the hands of parents but assessed in hands of child.
 - b) Income of child on account of manual work or activity involving **skill, talent or specialised knowledge or experience** etc. but if such income is **further invested**, any such income shall be **clubbed** in the income of mother or father.
7. Minor include **adopted, step and minor married daughter**.
8. Section 10(32) : If income of an individual includes the income of his minor child the individual shall be entitled to **exemption upto ₹1500 per child**.
This provision is provide relief to the individual in whose total income the income of minor child included[**Only for optional scheme**.]

Cross transfer

As per supreme court judgement such cross transfer shall be subjected to clubbing provisions, considering the same as tax evasion device.

Section 64(2) : Conversion into HUF property

If an individual who is a member of HUF converts his self occupied property as the property of the HUF, then the **income derived by HUF** from such property shall be **included in the income of member**.

Section 65 : Liability of the transferee in respect of clubbed income

If any particular income of one person has been clubbed in the income of a second person but **tax cannot be recovered from the second person** then income tax **authorities can demand the tax from the 1st person** only to the extent of his income was clubbed in the income of 2nd person.

Rules for clubbing of income /How to club income

Clubbing of income will also **include clubbing of losses** income shall be clubbed in the following manner :

STEP-1

Calculate the **income/loss in the hands of the recipient** as if it is the income of the recipient. All deductions under the relevant head will be allowed while calculating the income.

STEP-2

The income or losses calculated as above will then be clubbed with the **income of the transferor under the same head** (i.e., the head from which such income belongs). Exemption up to ₹1,500 per child per year is available under Section 10(32) in respect of the clubbing of income of a minor child.

STEP-3

Such clubbed income is the income of the transferor, and the provisions relating to set-off & carry forward of losses shall apply in the normal manner. Deductions under Sections 80C to 80U shall also be **allowed in the normal manner**.

Rules for clubbing of income /How to club income

1. The clubbing shall continue to apply even if the transferee has **converted the transferred assets to some other form**.
2. Income shall include **loss also**. Therefore, losses are also to be clubbed.
3. If the transferee **sells the transferred assets**, then **capital gain** shall also be **clubbed** with the income of the **transferor**.
4. Income arising out of the **income earned** on transferred assets shall not be clubbed **except in the case of a minor**.
5. The Supreme Court, in the case of J.H. Gotla, held that the clubbed income shall be retained under the same head in which it is earned. Therefore, the business income of a minor child shall be **clubbed in the hands of parents** under the head "Profits and Gains from Business or Profession (PGBP)." The business losses of the parent can be set off against such income.
6. While clubbing the income, the **deductions** available under the five heads of **income shall be allowed**, and the income after such deduction shall be clubbed.
7. Clubbing will take place even if the assets are indirectly transferred or transferred through **cross transfers**.
8. If an **interest-free loan** is given by a **husband to his wife** or by an **individual to a Hindu Undivided Family (HUF)**, and the person to whom the loan is given purchases an asset out of the loan, then the income from such an asset **shall not be clubbed** in the hands of the person who has given the loan. This is **because giving a loan is not a transfer of assets**. Clubbing applies when assets are transferred without or for inadequate consideration.
9. The HUF is a partner in firm XYZ through its karta, Mr. A, and has a **25% share** in the profits of the firm. The wife of Mr. A is **employed** by firm XYZ. In this case, clubbing shall not apply because Mr. A is a partner in a representative capacity and **not in his individual capacity**. Clubbing applies where an individual is a partner in his individual capacity, has a substantial interest in the firm, and his spouse gets remuneration from the firm.
10. If a trust is created for the benefit of a minor child, then the income of the trust shall be **clubbed with the income of the parent** under Section 64(1A). This shall apply even if the trust deed provides that the income shall be accumulated by the trust and shall be given to the minor child when he attains majority. Clubbing provisions under Section 64(1A) shall apply since the income accrues for the benefit of the minor child, although it may be given on attaining majority.

Chapter -9 set off and carry forward of losses

summary diagram of setoff and carry forward of losses

	Heads of Income	Setoff of Losses	Carry forward and setoff of Losses	Assessment year
1.	Salary	Not applicable	Not applicable	Not applicable
2.	House property	Optional scheme • Same head = no limit • Other head = upto ₹2,00,000 Default scheme • Same head = no limit • Other head = can't be setoff against any other head	Same head Losses can't carry forward	8 years
3.	Capital gain/loss • LTCG • STCG	• LTCG • STCG LTCG	• LTCG • STCG LTCG	8 years 8 years
4.	PGBP → Owning & Maintenance of horse races. → Speculative business → Loss form business specified u/s 35AD Other business (non specified business)	Owning & Maintenance of horse races. Speculative business Income form business specified u/s 35AD Any head, Any income except salary	Owning & Maintenance of horse races. Speculative business Income form business specified u/s 35AD Same head	4 years 4 years Indeterminate 8 years
5.	Other sources • Casual income • Other loss	• Not applicable • Any head, Any income	• Not applicable • Not applicable	• Not applicable • Not applicable

Steps for setoff

- STEP-1**
Loss should be set off from the **same source**. For example if there is loss from STCL then first it should be set off from STCG.
- STEP-2**
If after setting off loss from same source still there is loss, then it has to be set off from **different Source under same head**.
- STEP-3**
After **inter-source adjustment** only inter-head adj. can be made **No order** of inter-head adjustment is given by the Act. So, if inter head adjustment is allowed then losses should be set off in any way which is most beneficial to the assessee.

Steps for setoff

- As per section 72(2), Brought forward business Loss is to be set-off before setting off unabsorbed depreciation. Therefore, the **order** in which carry forward and set off will be affected, is as follows:
1. Current year **business Expenses**
 2. Current year **depreciation**/current year capital expenditure on scientific research and family planning.
 3. **Brought Forward** business loss (sec72)
 4. **Unabsorbed Depreciation** (sec 32(2) / family planning (sec 36)

Focus area

1. Whenever income is exempt then losses does **not have any tax treatment** means it should be ignored.
2. Loss from any lottery, card games, races etc are **not eligible for set off and clf** and losses cannot be set off against the income referred u/s 115BB. ie lottery income, crossword puzzles, incomes in TV shows etc.
3. B/f Losses from a business **can be set off** even if such **business is Not Continued**.
4. If there is income under any head and eligible losses under any other head, such loss shall be **first set off against the income** before set off and olf of losses.
5. Set off of losses **not permissible against unexplained income**, investment, money etc chargeable u/s. 68/69/69A/69B/69C/69D [Sec 115BBE]

Section 72A : Treatment of losses in case of amalgamation/succession

	Case	Accumulated business losses	Can be C/F by	Time limit
1.	Amalgamation Sec 2(1B)	Amalgamating Company	Amalgamated Company	Fresh period of 8 AY
2.	Demerger Sec 2(19AA)	Demerger company	Resulting company	Remaining period of 8 AY
3.	Conversion of firm / proprietary into co. Sec 47(xiii)/(xiv)	Firm/ proprietary concern	Successor company	Fresh period of 8 AY
4.	Unlisted co. Into LLP sec 47(xiiiib)	Unlisted company	LLP	Fresh period of 8 AY

Note :-

1. Unabsorbed depreciation can be carried forward by Amalgamated company/resulted co. Successor company LLP for **unlimited period**.
2. Only business losses **except** speculative business loss can be c/f by successor.

Chapter -10 Deduction from GTI

Deduction

1. Resident status	
2. Classification of 5 head	
3. Computation of 5 head	xxx
4. Add:- Clubbing of income	xxx
5. Less:- Setoff & carry forward Losses	(xxx)
6. Gross total income	xxx
7. Less:- Deduction u/s VI-A	(xxx)
8. Total income	xxx

Type of Deduction

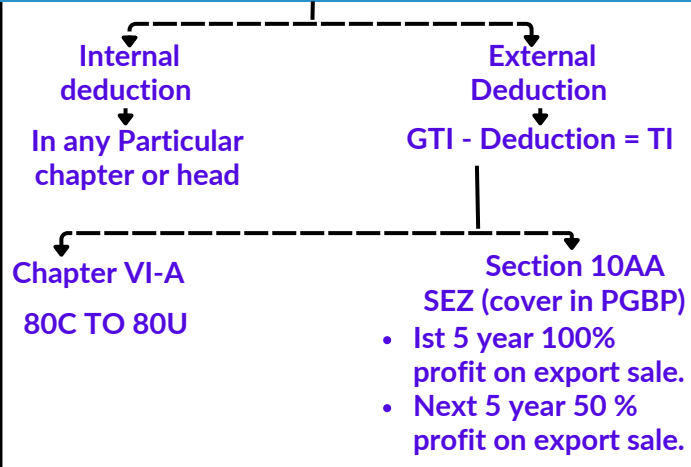

Type of Deduction

- Maximum deduction is allowed upto GTI.
- But deduction may be more than GTI.
- Total income can never be negative.
- Balance of deduction Cannot carry forward.

Income which IT 1961 cannot allowed deduction

- LTCG u/s 112
- LTCG u/s 112A
- STCG u/s 111A
- Casual income
- Online games income
- Black money

How to Compute GTI for deduction VI-A

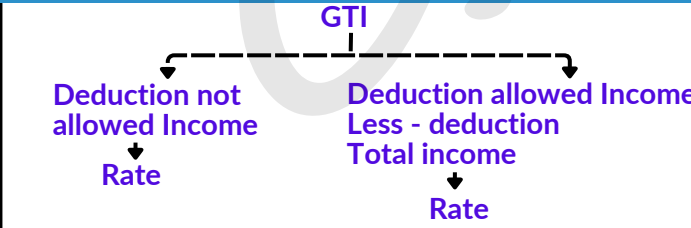

How to Compute GTI for deduction VI-A

- Only 3 deduction allowed to default scheme 80CCD(2),80CCH(2),80JJAA

Section 80C : Deduction in respect of investment in specified asset

- Eligible assessee :- **Individual or HUF**
- Sum paid deposit in the PY by way of
- Life insurance premium [Note 1][Note 2]
 - Contribution to PPFSPF/RPF and approved superannuation fund.[Note 2]
 - Repaying of housing loan taken from Govt,bank,LIC,Specified employer.
 - Tuition fees to any Indian university, college, school for full time education of any two children.
 - Term deposit for fixed period of not less than 5 years with schedule bank.
 - Subscription to notified bonds of NABARD.
 - Five year post office time deposit.
 - Senior citizen's saving scheme account.
 - Contribution by CG employee to additional account (Tier II A/c) of NPS referred to u/s 80CCD.
 - Deposit in Sukanya sumridhi scheme
 - Contribution towards ULIP

Aggregate maximum limit = ₹1,50,000

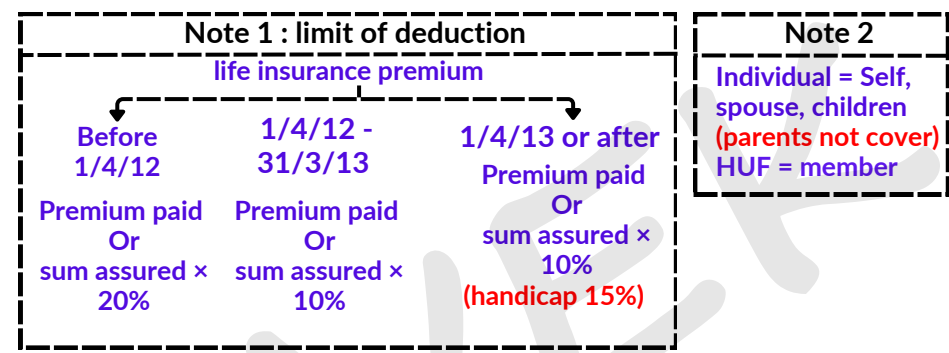

Section 80CCC : Contribution to Pension Funds

- Eligible assessee :- **Individual**
- Any amount paid or depend to keep in force a contract for any annuity plan of LIC of india or any other insurer for receiving Pension from fund.
- maximum limit = ₹1,50,000

Section 80CCD : Contribution to Pension scheme of CG

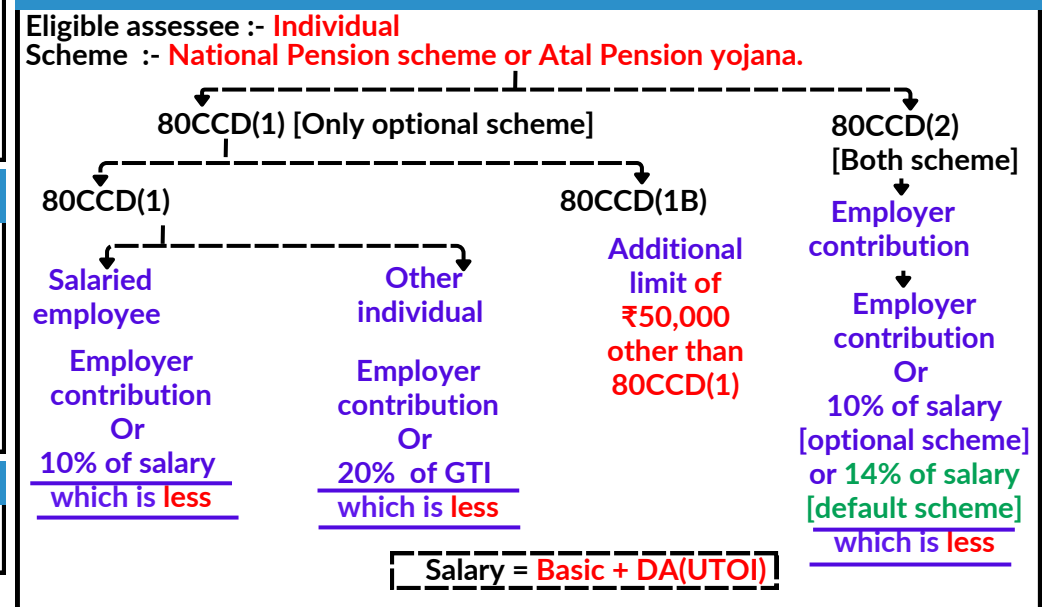

Section 80CCE : Contribution to Pension Funds

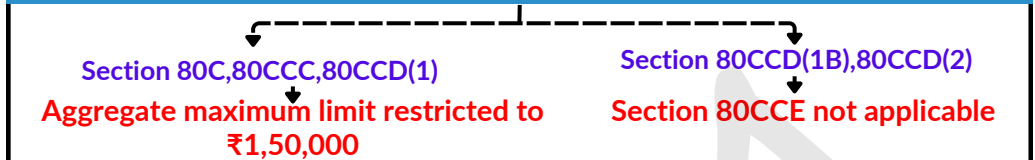

Section 80CCH : Contribution to agniveer corpus fund

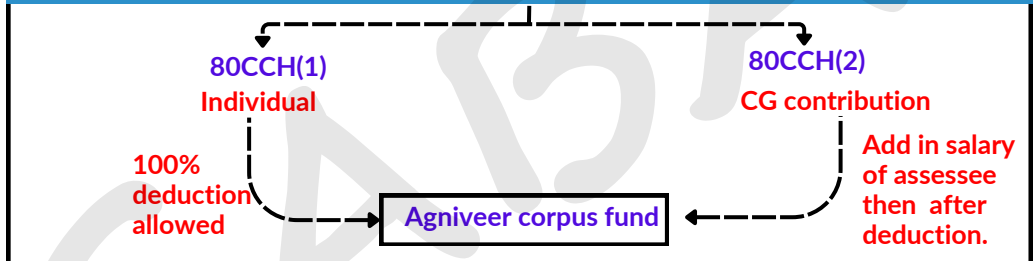

Section 80D : Medical insurance premium

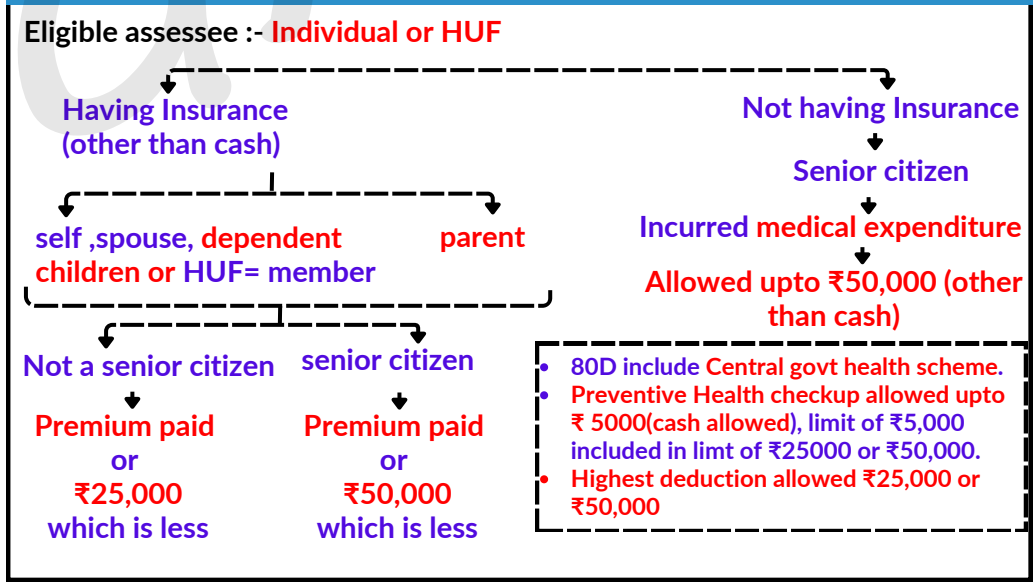

Treatment of disable children/parent /spouse/Brother/sister

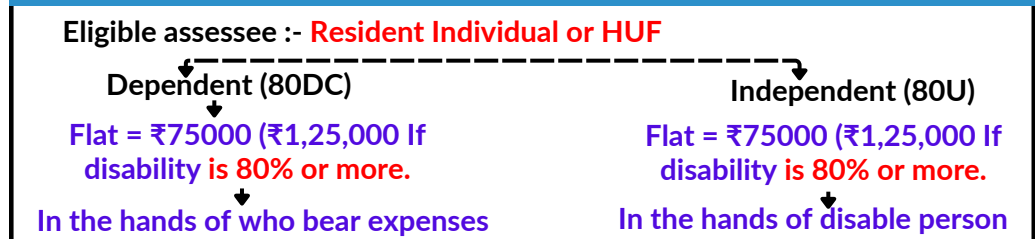

Section 80DDB : Medical treatment of specified diseases

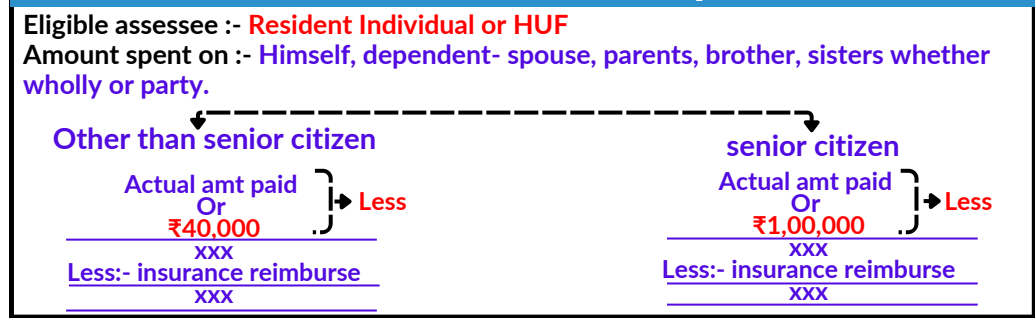

Chapter -10 Deduction from GTI

Deduction of interest on loan

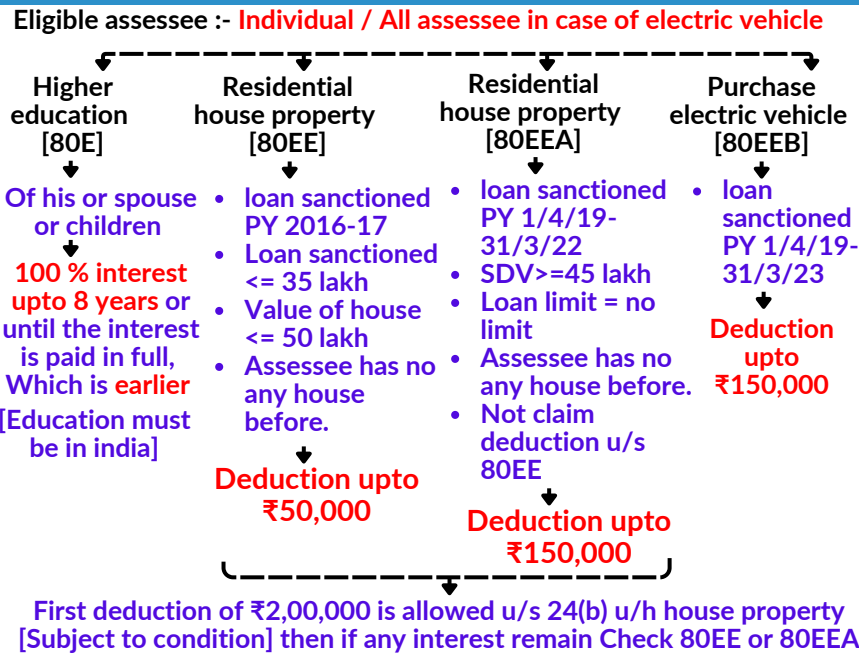

Section 80G : Deduction in respect of donation to certain fund ,charitable institution etc.

Eligible assessee :- **All assessee**

I	Donation qualifying for 100% deduction, without any qualifying limit
(1)	The National Defence Fund set up by the Central Government
(2)	Prime Minister's National Relief Fund.
(3)	Prime Minister's Armenia Earthquake Relief Fund
(4)	The Africa (Public Contributions-India) Fund
(5)	The National Children's Fund
(6)	The National Foundation for Communal Harmony
(7)	Approved University or educational institution of national eminence
(8)	Chief Minister's Earthquake Relief Fund, Maharashtra
(9)	Any fund set up by the State Government of Gujarat exclusively for providing relief to the victims of the Gujarat earthquake
(10)	Any Zila Saksharta Samiti constituted in any district for improvement of primary education in villages and towns and for literacy and post-literacy activities
(11)	National Blood Transfusion Council or any State Blood Transfusion Council whose sole objective is the control, supervision, regulation or encouragement in India of the services related to operation and requirements of blood banks
(12)	Any State Government Fund set up to provide medical relief to the poor
(13)	The Army Central Welfare Fund or Indian Naval Benevolent Fund or Air Force Central Welfare Fund established by the armed forces of the Union for the welfare of past and present members of such forces or their dependents.
(14)	The Andhra Pradesh Chief Minister's cyclone relief Fund,1996
(15)	The National illness Assistance fund
(16)	The chief minister relief Fund or Lieutenant governor's relief fund in respect of any state or union territory.
(17)	The National sports Fund setup by Central Government
(18)	The National cultural Fund setup by Central Government
(19)	The Fund for technology Development and application setup by Central Government.

Section 80G : Continue

(20)	National Trust for welfare of persons with Autism, Cerebral Palsy, Mental Retardation and Multiple Disabilities
(21)	The Swachh bharaat kosh, setup by the Central Government, other than the sum spent by the assessee in pursuance of CSR u/s 135(5) of companies act, 2013
(22)	The clean Ganga fund ,setup by the Central Government, where such assessee is a resident, other than the sum spent in pursuance of CSR u/s 135(5) of the companies act 2013
(23)	The National Fund for Control of drugs abuse
(24)	prime Minister's citizen assistance and relief in emergency situations Fund (PM care fund)
II	Donation qualifying for 50% deduction, without any qualifying limit
(1)	Prime Minister's drought relief fund
III	Donation qualifying for 100% deduction, Subject to qualifying limit
(1)	The Government or any approved local authority, institution or association for the promotion of family planning.
(2)	Sum paid by a company as donation to the Indian Olympic association or any other association/institution established in India, as may be notified by the Government for the development of infrastructure for sports or games, of the sponsorship of sports and games in India.
IV	Donation qualifying for 50% deduction, Subject to qualifying limit
(1)	Any Institution or Fund established in India for charitable purposes fulfilling prescribed conditions
(2)	The Government or any local authority for utilisation for any charitable purpose other than the purpose of promoting family planning
(3)	An authority constituted in India by or under any other law enacted either for dealing with and satisfying the need for housing accommodation or for the purpose of planning, development or improvement of cities, towns and villages, or both
(4)	Any Corporation established by the Central Government or any State Government for promoting the interests of the members of a minority community
(5)	For renovation or repair of Notified temple, mosque, gurdwara, church or other place of historic, archaeological or artistic importance or which is a place of public worship of renown throughout any State or States

Step for Computation of qualifying limit

Step 1	Compute adjusted total income i.e., the GTI as reduced by the following: (i) Deductions under Chapter VI-A, except under section 80G (ii) Short-term capital gain taxable under section 111A (iii) Long-term capital gains taxable under sections 112 & 112A (iv) Any income on which income-tax is not payable
Step 2	Calculate 10% of adjusted total income
Step 3	Calculate the actual donation, which is subject to qualifying limit (Total of Category III and IV donations, shown in the table above)
Step 4	Lower of Step 2 or Step 3 is the maximum permissible deduction.
Step 5	The said deduction is adjusted first against donations qualifying for 100% deduction (i.e., Category III donations). Thereafter, 50% of balance qualifies for deduction under section 80G.

Others points

1. Deduction for a donation cannot be claimed under multiple provisions or years.
2. Donations in kind are not eligible.
3. Cash donations above ₹2,000 are not allowed.
4. Deduction is allowed regardless of business connection.
5. Employees donating via employers to specific relief funds can claim deduction based on employer's certificate.
6. Deduction for certain donations is allowed based on information furnished by the institution, subject to verification.

Section 80GG : Rent paid for residential accommodation

Eligible assessee :- **Individual [Not getting HRA]**
 Least of the following :-
 1. 25% of Total Income
 2. Rent paid (-) 10% of Total Income → GTI (-) All deduction except 80GG
 3. ₹5,000 P.m
Deduction not allowed if house owned by assessee, his spouse, Minor child.

Section 80GGA : Donation for scientific research or rural development

Eligible assessee :- **Not having PGBP income**
 • 100% donation allowed [cash upto ₹2,000 allowed]

Contribution to political parties

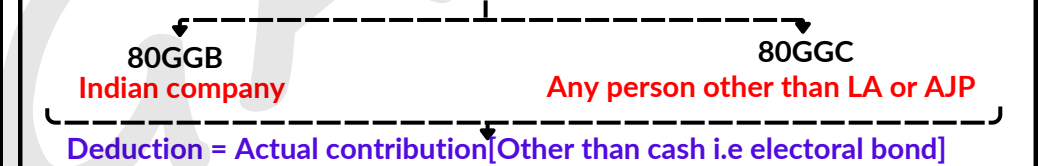

Section 80JJAA : Employment of New Employees

1. Deduction Amount & Period:
Businesses subject to tax audit under Section 44AB can claim a 30% deduction on additional employee costs for three assessment years, starting from the year in which the new employees are hired.
 2. Eligibility Conditions :
Assessee to whom Section 44AB applies, whose gross total income includes profits & gain derived from business.
 3. Key Definitions:
 - Additional Employee Cost: The salary paid to new employees hired during the previous year. If there is no net increase in employees, the additional employee cost is considered Nil. Payments must be made through banking channels (cheque, draft, UPI, NEFT, etc.).
 - Additional Employee: A new hire that increases the total employee count compared to the previous year. Exclusions:
 - ▶ Employees earning more than ₹25,000 per month.
 - ▶ Employees fully covered under the Government's Employees' Pension Scheme.
 - ▶ Employees not enrolled in a recognized provident fund.
 - ▶ Employees working less than 240 days in a year (150 days for apparel, footwear, and leather industries). However, if an employee completes 240/150 days in the next year, they will be counted for the deduction in that year.
- Emoluments:** Includes all payments to employees except employer's contributions to pension/provident funds and lump sum payments like gratuity, leave encashment, or severance

Deduction from GTI & AMT

Section 80M : Deduction in respect of inter corporate dividend

Eligible assessee :- **A domestic company**

Condition :-

The gross total income of domestic company includes in any PY, any income by way of dividend from any other domestic company or foreign company or a business trust.

Deduction :-

Amount of dividend received from other domestic company or foreign company or business trust or the amount of dividend such domestic company on or before the due date ,whichever is lower

Section 80QQB : Royalty income etc, of authors of certain books other than Text books

Eligible assessee :- **Resident Individual being an author**

Condition :-

Consideration for assessment or grant of any of his interests, in the copyright of any book, being a work of literary, artistic or scientific nature or royalty or copyright fee received as lumpsum or otherwise.

Deduction :-

- **Income derived** in the exercise of any profession or **₹3,00,000, whichever is less**
- **In respect of royalty or copyright fee received otherwise than by way of lumpsum**, income to be restricted to **15% of book Value sold** during the RPY.

Section 80RRB : Royalty on patents

Eligible assessee :- **Resident Individual being an patentee**

Condition :-

Any income by way of royalty on Patents registered on or after 1/4/2003.

Deduction :-

- **Income or ₹3,00,000, whichever is less.**

Section 80TTA/TTB: Interest on deposit

80TTA

Eligible assessee:- Individual or HUF **other than resident senior citizen**

- Interest on saving deposit Ist add u/h other source then claim deduction upto **₹10,000.**
- Interest on fixed deposit Ist add in other source and deduction not allowed.

Important point

- Exemption of section 10(15) of ₹3500 to Individual or ₹7,000 to joint account only if account open in post office.
- First Exemption allowed after deduction is less from GTI.

80TTB

Eligible assessee:- **resident senior citizen**

- Interest on saving deposit Ist add u/h other source then claim deduction upto **₹50,000.**
- Interest on fixed deposit Ist add u/h other source then claim deduction upto **₹50,000.**

Chapter-11 Alternate Minimum Tax (AMT)

Applicability of AMT [Section 115JEE(1)]

The provisions of Alternate Minimum Tax (AMT) are applicable to:

Any person other than a company who has **claimed a deduction under:**

- Any section (other than Section 80P) included in Chapter VI-A under the heading "C - Deductions in respect of certain incomes" (i.e., Sections 80-IA to 80RRB).
- Section 10AA (Special Economic Zone benefits).
- Section 35AD (Capital expenditure deduction for specified businesses).

Non Applicability of AMT [Section 115JEE(2)]

The provisions of AMT will not apply to the following persons:

- Individuals, HUFs, AOPs, BOIs, or artificial juridical persons if their **adjusted total income does not exceed ₹20 lakhs.**
- A resident co-operative society that has **exercised the option** under Section 115BAD or Section 115BAE.
- An individual, HUF, AOP, BOI, or artificial juridical person who is paying tax under the **default tax regime** of Section 115BAC.
- A **specified fund referred** to in clause (c) of Explanation to Section 10(4D).

Non Applicability of AMT [Section 115JEE(2)]

- The income tax payable by a person (other than a company) is **first computed as per the regular provisions** of the Income-tax Act, 1961.
- If applicable, AMT is payable at:
 - **18.5% of adjusted total income.**
 - **9% for a unit located in an IFSC** (International Financial Services Centre) deriving income solely in convertible foreign exchange.
 - **15% for a co-operative society.**
- The adjusted total income will be deemed to be the total income of the person, and AMT will be charged accordingly.

Setoff of AMT Credit [Section 115JD]

- If a person has paid AMT in a previous year, they are eligible to claim AMT credit in subsequent years.
- AMT credit can be set off to the extent that the regular tax liability in the future years exceeds the AMT liability.
- The credit can be carried forward for **15 assessment years** and utilized accordingly.

Computation of Adjusted Total income

Step 1: Start with Total Income

- **Total Income** (before applying AMT provisions)

Step 2: Add Back Deductions

Add :- Deductions claimed under:

- + Chapter VI-A other than Section 80P
- + Section 10AA (SEZ deduction)
- + Section 35AD (Capital expenditure deduction for specified businesses)

Step 3: Subtract Depreciation Adjustment

Less :- Depreciation under Section 32

(As if no deduction under Section 35AD was claimed for the asset)

Chapter -12 Advance Tax & TDS & TCS

TDS /TCS



- Concept of Surcharge or cess of TDS rate.
- Payment of TDS
- Return of TDS
- TDS certificate (Sec 203)
- Interest in case of default in payment of TDS [Sec 201(1)]&[Sec 201(1A)]
- Fees or penalty in case of default in return of TDS[Sec 234E]&[sec 271H]
- No deduction of TDS in certain cases
- Requirement of PAN (Sec 206AA)
- A.O Certificate (Sec 197)
- Self declaration (Sec 197A)

payment of TDS

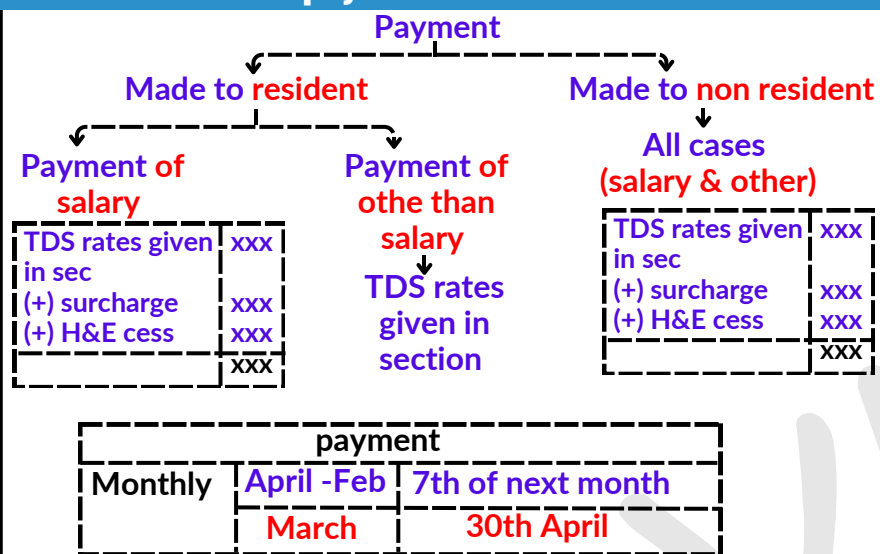

Return of TDS

Quarterly	April -june	31 July
	June-sept	31 oct
	Oct - Dec	31 Jan
	Jan - March	31 may

TDS certificate

Issue TDS certificate

Deductor	→ Deductee	
Form No.	16(salary)	16(other)
Period	Annual	Quarterly
	15 june of the following relevant Fy	15 days from the due date of furnishing TDS return- 15/08,15/11,15/12,15/06

Interest in case of default in payment of TDS

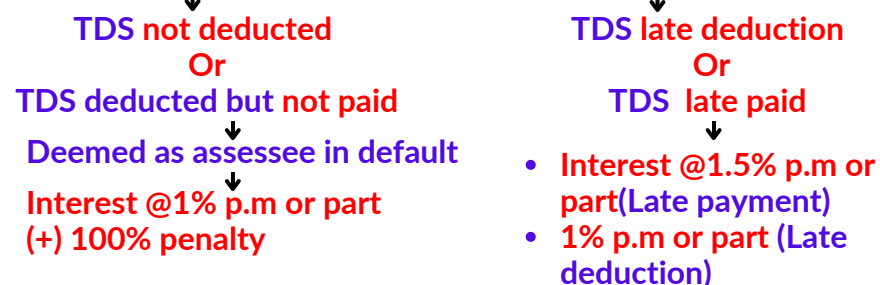

Fees or penalty in case of return

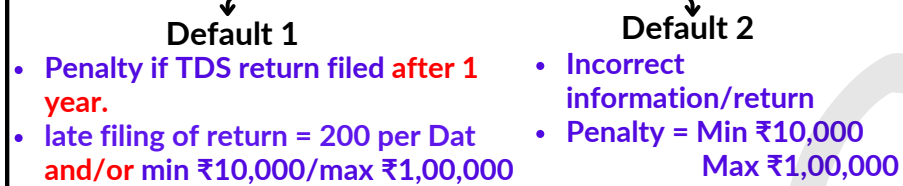

Section 196 : TDS not to be Deducted in following cases

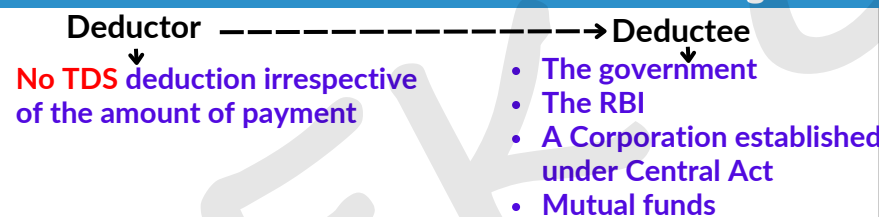

Section 206AA : TDS rates in case of default in submission of PAN

- If deductee fails to furnish PAN to deductor then ,deductor shall deduct TDS at Higher of the following:-
- Rates given in section.
 - Rates given in finance Act
 - 20% (5% in case of 194-O)

Section 197 : AO certificate for non deduction of TDS or lower deduction of TDS

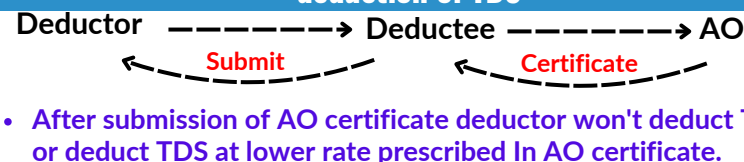

Section 197A : Self declaration for non deduction of TDS

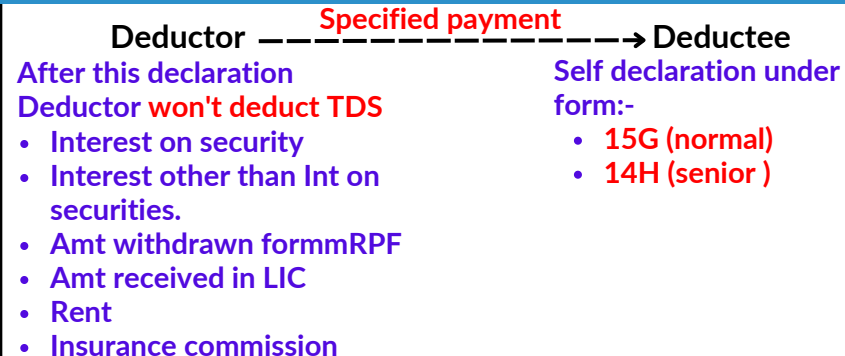

Section 192 : Salary

Payer	Employer
Payee	Individual Employee
Threshold limit	Basic exemption limit
Rate of TDS	Average rate of income-tax
Time of deduction	At the time of payment of salary

1. Employees must inform employers if opting out of the default tax regime (u/s 115BAC); otherwise, the default regime applies.
2. Employers can pay tax on non-monetary perquisites instead of deducting from salary.
3. Employees working for multiple employers in a financial year should provide income details for proper TDS computation.
4. Relief u/s 89(1) is allowed for eligible employees.
5. Employees can declare additional income (e.g., house property loss) for TDS calculation, with a maximum set-off of ₹2,00,000 for house property loss if opting out of the default regime.
6. Employers must issue Form 12BA for employees earning above ₹1,50,000; others receive Form 16 with perquisite details.
7. Employers must follow annual CBDT circulars for TDS compliance.
8. Proof required for deductions:
 - HRA: Landlord's details if rent > ₹1 lakh/year.
 - LTC: Proof of travel expenses.
 - House property interest deduction: Lender's details.
 - Chapter VI-A deductions: Proof of investment/expenditure.

Section 192A : Premature withdrawal from employees Provident

Payer	Trustee of EPF Scheme or authorized person
Payee	Individual Employee
Threshold limit	₹50,000 (payment or aggregate payment)
Rate of TDS	10% on taxable premature withdrawal
Time of deduction	At the time of payment

1. Exemptions from TDS:
 - Withdrawal after continuous service of 5 years.
 - Withdrawal before 5 years if:
 - Balance is transferred to a new employer.
 - Termination due to ill health, business discontinuance, or cessation of employment.

Section 193 : Interest on securities

Payer	Any person responsible for Paying Interest on securities
Payee	Any resident person
Threshold limit	>₹10,000 or >₹5,000 [Note 1]
Rate of TDS	10%
Time of deduction	At the time crediting interest to payee a/c or payment , whichever is earlier.

Chapter -12 Advance Tax & TDS & TCS

Section 193 : Continue

- >₹10,000 for interest on 8% Savings Bonds (2003), 7.75% Savings Bonds (2018), Floating Rate Savings Bonds (2020), or any other notified government security (effective from 01.10.2024).
>₹5,000 for interest on debentures (listed or unlisted) issued by a widely held company, paid to a resident individual/HUF via an account payee cheque.
- No TDS on interest from:
 - National Development Bonds & 7-Year National Savings Certificates (IV Issue).
 - Debentures issued by notified public sector companies, institutions, or co-operative societies.
 - Power Finance Corporation Limited (PFCL) & Indian Railway Finance Corporation Limited (IRFCL) 54EC Capital Gains Bonds.
 - Any Central or State Government security, except specific taxable bonds exceeding ₹10,000 interest.
 - Securities owned or beneficially held by LIC, GIC, subsidiaries of GIC, or any other insurer

Section 194 : Dividend

Payer	Principal officer of domestic company
Payee	Resident shareholder
Threshold limit	>₹5,000 (only for individuals receiving other than cash); No threshold in other cases
Rate of TDS	10%
Time of deduction	Before making any payment or distribution of dividend

1. Exemptions from TDS:

- Dividend paid to LIC, GIC, subsidiaries of GIC, or any insurer if they own or have full beneficial interest in the shares.
- Any other person notified by the Central Government.

Section 194A : Interest other than interest on securities

Payer	Any person other than individual/HUF (IND/HUF liable T/O >1cr or GR > 50lakh)
Payee	Any resident person receiving interest
Threshold limit	<ul style="list-style-type: none"> General limit >₹5,000 Special limits [Note 1]
Rate of TDS	10%
Time of deduction	At the time crediting interest to payee a/c or payment, whichever is earlier.

1. Specified limit

- For banks, co-op banks & post offices: ₹40,000 (₹50,000 for senior citizens).
 - For co-op societies (if turnover > ₹50 crore): ₹40,000 (₹50,000 for senior citizens).
 - Motor Accident Claims Tribunal compensation: ₹50,000.
- ### 2. No TDS on Interest Paid By/To:
- Firms to partners.
 - Deposits under notified government schemes.
 - Interest on savings deposits with banks (except time deposits after 1.7.1995).

Section 194A : Continue

- Co-op societies paying interest to members or other co-op societies (unless turnover > ₹50 crore).
- Government interest payments under the Income-tax Act.
- Banks, LIC, insurance companies, financial corporations, UTI, and notified institutions (e.g., HUDCO, NSDF).
- Interest on compensation by Motor Accident Claims Tribunal (if ≤ ₹50,000).
- Interest on zero-coupon bonds issued post-1.6.2005 by specified entities

Section 194B: winnings from lottery, puzzle, card games, gambling, betting

Payer	Any person
Payee	Any person
Threshold limit	Amount >₹10,000
Rate of TDS	30%
Time of deduction	At the time of payment

Section 194BA : winnings from online games

Payer	Any person
Payee	Any person
Threshold limit	Amount >₹10,000
Rate of TDS	30% TDS on net winnings
Time of deduction	At the time of withdrawal or end of FY

1. Other Points:

- If winnings are in kind or partly in cash (insufficient for TDS), the payer must ensure tax payment before release.
- If winnings and losses are credited/debited in a user account, TDS applies before setting off losses, and net amount (after tax and losses) is paid.

Section 194BB : winnings from horse race

Payer	person holding license of horse race
Payee	Any person
Threshold limit	Amount >₹10,000
Rate of TDS	30%
Time of deduction	At the time of payment

Section 194C : Payment to contractors

Payer	Any person
Payee	Resident contractor
Threshold limit	<ul style="list-style-type: none"> >₹30,000 per contract >₹1,00,000 Aggregate per FY
Rate of TDS	1% for ind/HUF, 2% for other
Time of deduction	At the time credited or payment, whichever is earlier.

Section 194C : continue

- "Work": Includes advertising, broadcasting, transport (excluding railways), catering, and manufacturing as per customer specifications (if material is supplied by the customer).
- Valuation for TDS: If material value is separately mentioned in the invoice, TDS applies only on the service component; otherwise, it applies to the full invoice amount.
- Exemptions:
 - No TDS on payments to transport contractors if they own ≤10 goods carriages, are engaged in transport business, and provide PAN and declaration.
 - No TDS on professional services (covered under Section 194J).
- Non-applicability to Contracts for Sale: TDS applies only to works and labor contracts, not pure sales contracts.
- Motor Vehicles Definition: Includes goods carriages but excludes vehicles with <4 wheels, ≤25cc engine, or those running on rails/factory premises.

Section 194D : Insurance commission

Payer	Any person
Payee	Any resident person
Threshold limit	Amount >₹15,000 in FY
Rate of TDS	<ul style="list-style-type: none"> 5% for non corporate resident 10% for domestic company
Time of deduction	At the time credit or payment, whichever is earlier.

Section 194DA : Any sum under life insurance policy

Payer	Any person
Payee	Any resident person
Threshold limit	Amount > ₹1,00,000 in FY
Rate of TDS	<ul style="list-style-type: none"> 5% on the income portion (till 30.09.2024). 2% on the income portion (w.e.f. 01.10.2024).
Time of deduction	At the time of payment

- No TDS if the sum received qualifies for exemption under section 10(10D)

Section 194G : Commission from lottery tickets

Payer	Any person commission or prize on lottery
Payee	Any person distributing, selling tickets
Threshold limit	Amount > ₹15,000 in FY
Rate of TDS	<ul style="list-style-type: none"> 5% (till 30.09.2024). 2% (w.e.f. 01.10.2024).
Time of deduction	At the time credit or payment, whichever is earlier.

Chapter -12 Advance Tax & TDS & TCS

Section 194H : TDS on Commission & Brokerage

Payer	Any person other than individual/HUF (IND/ HUF liable T/O >1cr or GR > 50lakh)
Payee	Any resident person (other than cover u/s 194D)
Threshold limit	Amount > ₹15,000 in FY
Rate of TDS	<ul style="list-style-type: none"> 5% (till 30.09.2024). 2% (w.e.f. 01.10.2024).
Time of deduction	At the time credit or payment, whichever is earlier.

1. Other Points:
- Commission includes payments for services, buying/selling of goods, or transactions involving assets.
 - No TDS on professional services (legal, medical, engineering, etc.).
 - No TDS on commission paid by BSNL/MTNL to PCO franchisees.
 - No TDS on payments by TV channels/newspapers to ad agencies for booking advertisements.

Section 194-I : Rent

Payer	Any person other than individual/HUF (IND/ HUF liable T/O >1cr or GR > 50lakh)
Payee	Any resident person
Threshold limit	Amount > ₹2,40,000 in FY
Rate of TDS	<ul style="list-style-type: none"> 2% for plant, machinery or equipment. 10% for land, building furniture or fittings
Time of deduction	At the time credit or payment, whichever is earlier.

1. Other Points:
- Rent includes payments for land, building, plant, machinery, furniture, or fittings.
 - No TDS on cooling charges paid to cold storage owners (TDS under 194C applies).
 - No TDS on Passenger Service Fees (PSF) paid by airlines to airport operators.
 - TDS is deducted on rent excluding GST if mentioned separately in the agreement.
 - No TDS on lump sum lease premium or upfront lease charges for long-term lease.

Section 194-IA : T/F of immovable property other than Agricultural land

Payer	Any person other than cover u/s 194LA
Payee	Any resident person
Threshold limit	Amount > ₹50,00,000 (Consideration or SDV, whichever is higher)
Rate of TDS	1% of Consideration or SDV, whichever is higher
Time of deduction	At the time credit or payment, whichever is earlier.

1. Other Points:
- No requirement of TAN under Section 203A.
 - Consideration includes club membership fees, parking fees, maintenance charges, etc.
 - From 01.10.2024, if there are multiple transferors or transferees, TDS applies on the total amount paid by all transferees.

Section 194B : Payment of rent by Ind/HUF

Payer	Ind/HuF not deduct TDS u/s 194-I
Payee	Resident person
Threshold limit	Rent exceeding ₹50,000 per month
Rate of TDS	<ul style="list-style-type: none"> 5% (till 30.09.2024). 2% (w.e.f. 01.10.2024).
Time of deduction	Last month of the FY or tenancy, whichever is earlier

1. Other Points:
- No requirement to obtain TAN under Section 203A.
 - "Rent" includes payments under lease, sub-lease, or tenancy for land or buildings.
 - If tax deduction is under Section 206AA (due to no PAN), TDS cannot exceed the last month's rent.

Section 194J : Fees for professional or technical services

Payer	Any person (except ind/HUF not covered under tax audit.)
Payee	Resident professional, technical service providers, director, royalty recipient, non compete fee recipient.
Threshold limit	₹30,000 per FY (Separately for each category) No limit for payments to directors.
Rate of TDS	2% for technical services(except professional services),2% for Royalty on cinematographic film and call center; 10% for others.
Time of deduction	At the time credit or payment, whichever is earlier.

1. Other Points:
- Individuals/HUFs covered under tax audit must deduct TDS on professional/technical fees.
 - No TDS if payment is for personal purposes.
 - "Professional services" include legal, medical, engineering, IT, advertising, film artists, sports-related services, etc.
 - "Fees for technical services" include managerial, technical, consultancy services, but exclude construction, mining, or salary payments.
 - TPAs must deduct TDS on payments to hospitals for medical services.
 - Consideration for software use/license is treated as royalty and subject to TDS.
 - Exemption from TDS on software payments if acquired without modification and tax was deducted in prior transfer.

Section 194K : Income from units other than nature of CG

Payer	Mutual fund, specified undertaking, or specified companies
Payee	Any resident person
Threshold limit	Amount > ₹5,000 in FY
Rate of TDS	10%
Time of deduction	At the time credit or payment, whichever is earlier.

- Applicable only on income from units, not on capital gains.

Section 194LA : Compensation for acquisition of immovable property other than Agricultural land in india

Payer	Any person
Payee	Any person
Threshold limit	Amount > ₹2,50,000 in FY
Rate of TDS	10%
Time of deduction	At the time of payment

- TDS provisions do not apply to compensation for the acquisition of agricultural land in India, whether rural or urban.

Section 194M : Payment by Ind/HUF to- contractors, commission or brokerage, Fees for professional services

Payer	Ind/HUF not deduct TDS u/s 194C,194H,or 194J
Payee	Any person
Threshold limit	Consideration > ₹50,00,000 in FY
Rate of TDS	<ul style="list-style-type: none"> 5% (till 30.09.2024). 2% (w.e.f. 01.10.2024).
Time of deduction	At the time credit or payment, whichever is earlier.

- No TDS required if the payer is already liable under Sections 194C, 194H, or 194J.
- No requirement to obtain TAN.

Section 194N : TDS on Cash Withdrawal

Payer	Bank, cooperative society, Post office
Payee	Any person withdrawing cash
Threshold limit	₹1 crore (₹3 crore for co-operative society)
Rate of TDS	<ul style="list-style-type: none"> 2% 5% If withdrawal exceeds ₹1crore/₹3crore in case of co-operative society
Time of deduction	At the time of payment

- For non-filers of ITR (last 3 years):
 - 2% on cash withdrawal > ₹20 lakh but ≤ ₹1 crore (₹3 crore for co-op societies).
 - 5% on cash withdrawal > ₹1 crore (₹3 crore for co-op societies).
- Exemptions: Government, banks, co-op banks, post offices, business correspondents, white-label ATM operators.
- Central Govt. may notify exclusions or reduced rates with RBI consultation.

Section 194P: Pension & interest For senior citizen

Payer	Notified specified banks
Payee	Specified senior citizen (75 years or older, having only pension & interest income from the same bank)
Threshold limit	Basic exemption limit
Rate of TDS	As per applicable slab rates
Time of deduction	At the time of computing total income& deducting tax.

- Bank computes total income, allows deductions (Chapter VI-A) & rebate (87A) before deducting tax.
- No requirement to file ITR if tax is deducted under this section.

Chapter -12 Advance Tax & TDS & TCS

Section 194Q : Purchase of goods

Payer	Buyer (having T/O > 10cr in preceding FY)
Payee	Any resident person
Threshold limit	Purchase > ₹50,00,000 in PY
Rate of TDS	0.1% on sum exceeding ₹50,00,000
Time of deduction	At the time credit or payment, whichever is earlier.

1. TDS not applicable if tax is deductible under other provisions or collectible under 206C (except 206C(1H)).
2. If both 194Q & 206C(1H) apply, TDS under 194Q is applicable.
3. Crediting the sum to any account (e.g., suspense account) is considered as credit for TDS purposes.

Section 194R : TDS on Benefits or perquisites

Payer	Any person other than individual/HUF (IND/HUF liable T/O > 1cr or GR > 50lakh)
Payee	Any resident person receiving benefit /perquisite
Threshold limit	Value > ₹20,000 in FY
Rate of TDS	10% of value of Perquisite/benefit
Time of deduction	Before providing benefits/perquisites

1. Applicable to benefits/perquisites in cash, kind, or both.
2. If provided wholly in kind or partly in cash but cash is insufficient for TDS, the provider must ensure tax is paid before releasing the benefit.

Tax collection at source

Section 206C(1) : sale of certain goods

Seller	Person selling goods specified u/s 206C(1)
Buyer	Any person
Consideration	
Rate of TCS	<ul style="list-style-type: none"> Alcoholic liquor = 1% Tendu leaves = 5% Timber = 2.5% other forest produce = 2.5% Scrap = 1% Minerals (coal, lignite, iron ,ore) = 1%
Time of Collection	At time of debited or payment which is earlier

1. No TCS applies if the resident buyer submits a declaration that goods are for manufacturing, processing, production, or power generation, not trading.
2. No TCS if purchase for personal use.

Section 206(1C) : lease or license of parking lot ,mine or quarry

Seller	Any person granting a lease, license or contract for a parking lot ,toll plaza, mine or quarry
Buyer	Any person (license or lease (except public sector companies) using asset for business purpose.
Consideration	
Rate of TCS	2%
Time of Collection	At time of debited or payment which is earlier

1. Mining and quarrying exclude mineral oil (petroleum and natural gas).

Section 206(1F) : Sale of moter vehicle

Seller	Any person receiving consideration for selling a moter vehicle or other notified goods exceeding ₹10 lakh
Buyer	Any purchaser
Consideration	Sale > 10,00,000
Rate of TCS	1% of sale consideration
Time of Collection	At time of receipt of consideration.

1. From 01.01.2025, TCS also applies to other notified goods exceeding ₹10 lakhs.

Section 206(1G) : remittance under LRS of RBI or overseas tour package

Seller	<ul style="list-style-type: none"> Authorized dealer receiving remittance under LRS seller of overseas tour package
Buyer	<ul style="list-style-type: none"> Person remitting money under LRS Person purchase an overseas tour package
Consideration	
Rate of TCS	<ul style="list-style-type: none"> Overseas tour package = 5% upto ₹ 7 lakh; 20% thereafter Education/medical remittance = No TCS upto ₹ 7 lakh ; 5% more than ₹7 lakh. Education loan remittance = 0.5% beyond ₹7lakh Other remittance = 20%beyond ₹7 lakh
Time of Collection	At time of debited or payment which is earlier

1. No TCS if:
 - Already collected by the seller.
 - Buyer deducts TDS under other provisions.
 - Buyer is the government, diplomatic entities, or notified persons.
 - Buyer is a non-resident without a permanent establishment in India

Section 206(1H) : Sale of goods exceeding ₹50 lakh

Seller	Any person receiving consideration for the sale of goods exceeding ₹50 lakh (Excluding exports and goods u/s 206C(1),(1F),or (1G).
Buyer	Any purchaser
Consideration	sale above ₹50 lakh in PY
Rate of TCS	0.1% on the amount exceeding ₹50 lakh
Time of Collection	At time of receipt of consideration.

1. No TCS if the buyer deducts TDS under any other provision of the Act.

Advance Tax

Liability for payment of advance tax

- Applicable if advance tax payable is ₹10,000 or more (Section 208).
- Exemption for Senior Citizens (60+ years) if they have no income from business/profession.
- Advance tax is paid on estimated current income.
- No penalty under Sections 234B & 234C if advance tax liability is below ₹10,000.

Computation of Advance tax

- Self-estimation method or as per Assessing Officer's (AO) order (Section 210).
- AO may amend the order before 1st March based on updated income.
- Tax calculated is reduced by TDS actually deducted (not just deductible).
- Net agricultural income is considered for computation.

Advance tax Installment & Due dates

Due date	Minimum % of Advance tax payable
15th june	15%
15th sept	45% (Cumulative)
15th Dec	75% (Cumulative)
15th March	100%(Cumulative)

For presumptive taxable (Section 44AD/44ADA)

- Entire Advance paid before 15th march
- What if Advance tax not paid before due date but paid before 31/3 ?
- Treatment as advance tax but assessee bear penalty or interest.

Section 234B : Interest on late payment

Applicability = Advance tax paid during the PY < 90% of Actual tax

Value. = Actual tax (-) Advance Tax paid during PY
 Interest = 1% per month or part of month
 Time = 1 April to until tax paid/assessment done

Section 234C : Interest on late payment or Deferment instalment

Due date	Minimum Tax govt wants	Tax actual paid	If shortfall arise	Interest on shortfall	period
15th june	15%	x	x	1% per month	3 month
15th sept	45%	x	x	1% per month	3 month
15th Dec	75%	x	x	1% per month	3 month
15th Mar	100%	x	x	1% per month	1 month

- Exception: No interest if advance tax paid by 15th June & 15th September is at least 12% & 36% of 45% & 75%
- No interest under 234C for:
 - Capital gains
 - Lottery winnings
 - First-time business/profession income
 - Dividend income (excluding deemed dividend u/s 2(22)(e))

Chapter - 13 Return

Section 139(1) Assessee required to file return compulsorily

Assessee required to File Return

- **Mandatory for Companies & Firms** irrespective of profit, loss, or nil income.
- **Residents with Foreign Assets/Interests** – Includes beneficial ownership, signing authority, etc., even if no taxable income.
- **Individuals, HUFs, AOPs, BOIs, Artificial Juridical Persons** – If total income (before deductions under Chapter VI-A, Sections 54, 54B, 54D, 54EC, 54F) **exceeds the basic exemption limit.**
- **Other Persons (Not Company or Firm) Meeting Specific Criteria:**
 - Deposits in current accounts > ₹1 crore.
 - Foreign travel expenses > ₹2 lakh.
 - Electricity consumption > ₹1 lakh.
 - Other prescribed conditions.
- **Additional Criteria for Compulsory Filing (If not otherwise required under Section 139(1)):**
 - Business Turnover > ₹60 lakh (previous year).
 - Professional Gross Receipts > ₹10 lakh (previous year).
 - TDS + TCS Aggregate ≥ ₹25,000 (for residents) / ₹50,000 (for senior citizens aged 60+).
 - Savings Bank Deposits ≥ ₹50 lakh (during previous year).

Due Dates for Filing Return

- **31st October** – Companies, entities requiring audit, and partners of firms requiring audit.
- **30th November** – Assessee required to file a report under Section 92E (international transactions).
- **31st July** – All other assesseees.

Section 139(3) : Return of loss

1. Loss Carry Forward Condition:

- An assessee can carry forward or set off losses **only if the return is filed within the due date** specified under Section 139(1)

2. Exceptions:

- **Loss from House Property** and **Unabsorbed Depreciation** can be carried forward for set-off even if the return is filed after the due date.

Section 139(4) : Belated return

1. A Belated Return is a return of income that is filed after the due date specified under Section 139(1) but within the prescribed time limit.

2. Time Limit for Filing Belated Return

- A belated return for a previous year can be filed **before the earlier of the following:**
 - **Three months before the end** of the relevant assessment year For P.Y. 2024-25, the deadline is **31.12.2025.**
 - **Completion of the assessment** by the Assessing Officer.

Thus, if the assessment is completed before 31st December 2025, the return cannot be filed after that date.

Section 234(F) : Belated return

- Fee for late filing of return under Section 139(1): **₹5,000.**
- Reduced fee to **₹1,000** if total income ≤ ₹5 lakhs.

Section 139(5) : Revised return

1. A Revised Return is a return that an assessee can file to correct **any omission or wrong statement in the original return** filed under Section 139(1) or a belated return filed under Section 139(4).
2. **Time Limit** for Filing a Revised Return
 - A revised return can be filed **before the earlier of the following:**
 - **Three months before the end** of the relevant assessment year For P.Y. 2023-24, the deadline is **31.12.2024.**
 - **Completion of the assessment** by the Assessing Officer.

Important Points

- A belated return can also be **revised** under Section 139(5).
- The revised return **replaces** the original or belated return.
- It allows correction of errors but should **not be misused for tax evasion.**

Section 234A : Interest for default in furnishing return

Applicability of Interest

Interest under Section 234A is payable if:

- The return is filed **after the due date**, or
- **No return** is filed by the assessee.

Rate & Calculation of Interest

- Simple interest @ **1% per month (or part of a month).**
- Interest period: From the **day after the due date until the earlier of:**
 - **Filing of the return** (if filed late).
 - **Completion of assessment** (if no return is filed).

Exception

- No interest is payable if the assessee has **paid all taxes in full on or before the due date.**

Section 140A : Self Assessment

- Self-assessment tax must be **paid before filing a return** under Section 139 **after adjusting:**
 1. Tax already paid (**Advance Tax**/Self-Assessment Tax).
 2. **TDS/TCS** deducted or collected.
 3. **Relief** under Section 89 (for salary arrears, etc.).
 4. **Tax credit** under Section 115JD (if shifting from the default tax regime under Section 115BAC(1A)).
 5. **Tax and interest** payable under Section 191(2).
- If the payment made under Section 140A(1) is insufficient, it is adjusted in the **following order:**
 1. **First** – Fee payable.
 2. **Second** – Interest payable.
 3. **Third** – Balance tax payable.

Section 139(9) : Defective Return

- If the Assessing Officer (AO) finds a **defective return**, he will notify the assessee.
- The assessee must rectify the defect **within 15 days of intimation** (or within an extended period allowed by the AO).
- If not rectified within the given period, the return is treated as **invalid**, and it is considered as if no return was filed.
- If the defect is **rectified after 15 days but before assessment**, the AO may condone the delay and **treat the return as valid.**

Section 139(8A) : Updated return

- An Updated Return is a return that allows an assessee to correct or update their income details **within 24 months** from the end of the relevant assessment year, even if they have **not filed any return earlier** or have already filed an original, belated, or revised return.
- The provisions of updated return would **not apply if**
 1. It is a **loss return.**
 2. It **reduces total tax liability** from the earlier return.
 3. It results in or **increases a refund.**
- Assessee not allowed to file updated return if:
 1. An updated return has **already been filed** for the same year.
 2. Any assessment, reassessment, recomputation, or revision is **pending or completed.**
 3. The person or class of persons is **notified by CBDT** as ineligible

Section 140B : Tax on Updated Return

1. Tax, interest, fee, and additional tax must be paid before filing an updated return under Section 139(8A).
2. Computation of Tax Payable (**after adjusting** the following):
 - **Advance tax** already paid.
 - **TDS/TCS** deducted or collected.
 - **Relief** under Section 89 (for salary arrears, etc.).
 - **Tax credit** under Section 115JD (if shifting from the default tax regime under Section 115BAC).
3. If **no return was filed earlier:**
 - **Interest** under Section 234A applies on tax payable.
 - **Payment of additional tax** under Section 140B(3) is required.
4. If a **return was filed earlier** under Section 139(1), 139(4), or 139(5):
 - Tax is payable after **reducing interest** already paid in earlier returns.
 - The tax payable is increased by any **refund received** on the earlier return.
5. **Additional Income Tax on Updated Return:**
 - **25% of total tax & interest** if filed **within 12 months** from the end of the relevant assessment year.
 - **50% of total tax & interest** if filed between **12 to 24 months** from the end of the relevant assessment year.
6. **Proof** of payment of tax, additional tax, and interest must be submitted with the updated return.

Section 139A : Permanent account number (PAN)

PAN is mandatory for:

1. All income tax returns and correspondence with tax authorities.
2. All tax **payment challans** under the Income Tax Act.
3. Specified transactions (as per CBDT), e.g., **purchase of a vehicle, cash payment over ₹50,000 at a hotel, etc.**

Interchangeability of PAN & Aadhaar:

1. If a person does not have a PAN but has Aadhaar, they can **quote Aadhaar instead of PAN.**
2. If a person has **PAN and has linked it with Aadhaar** as per Section 139AA(2), they can use Aadhaar in place of PAN.

Section 139AA : Quoting of Aadhaar

- Aadhaar must be quoted in PAN application & income tax returns from 1st July 2017.
- If Aadhaar is not available, the Aadhaar Enrolment ID must be quoted.
- PAN-Aadhaar linking deadline: 31st March 2022 for those who had PAN as of 1st July 2017 and were eligible for Aadhaar.
- Penalty for non-linking by 31st March 2022: PAN becomes inoperative, and a ₹1,000 fee is payable as per Section 234H & Rule 114(5A).
- If Aadhaar is linked after 31st March 2022 (with fee payment), PAN becomes operative within 30 days.
- Inoperative PAN consequences effective from 1st July 2023 (Circular No. 3/2023, dated 28th March 2023).

"If You Think You Can, Then You Can Do Anything"

- by VG Sir

- FCA, B.com & CCTP
- Faculty for
- CA Intermediate - Direct Tax & Indirect Tax
- Qualified as Chartered Accountant at the age of 20
- Started teaching Taxation Laws in 2014 to CS students. Now regarded as the "Taxation King for CA Students Also"
- Makes difficult subject like Tax, simple to understand and teaches in a joyous environment
- Plays multiple roles as a Teacher, Guide, Mentor, Motivator, Big Brother & Friend to his students.
- He focuses upon overall development of the student
- In 2019, sir was the speaker of JoshTalk and shared his journey of becoming a CA.
- The video received more than 1.4 million views till date



Office Address

D-223/1, 1st Floor,
Vikas Marg, Near
Laxmi Nagar Metro
Gate No. 5, Delhi -1

Classroom Address

D323 1st Ameena Complex
Gali No 12 Near Sachdeva
Juice Corner
Laxmi Nagar Delhi 1

FOR FREE CLASSES & NOTES



YOU TUBE



TELEGRAM



WEBSITE



CA VIVEK GABA

FCA, B.com & CCTP

CONTACT US ON  **9643036663 (Only WhatsApp) or**



Visit Our Website at www.vgstudyhub.com | www.caarunsetiaclass.com **Visit for CA at** www.ultimateca.com